

We Yataghan Enterprise Co., Ltd.
 established a comprehensive customer service system,
 providing all-around pre-sales consultation,
 after-sales support, and product maintenance services.

Enjoy working with Miracle Tools!

Whether you are an individual consumer or a corporate client,
 we are committed to offering you the best tool and best service.



MIRACLE TOOLS 2023 SUMMER

YATAGHAN ENTERPRISE CO., LTD.

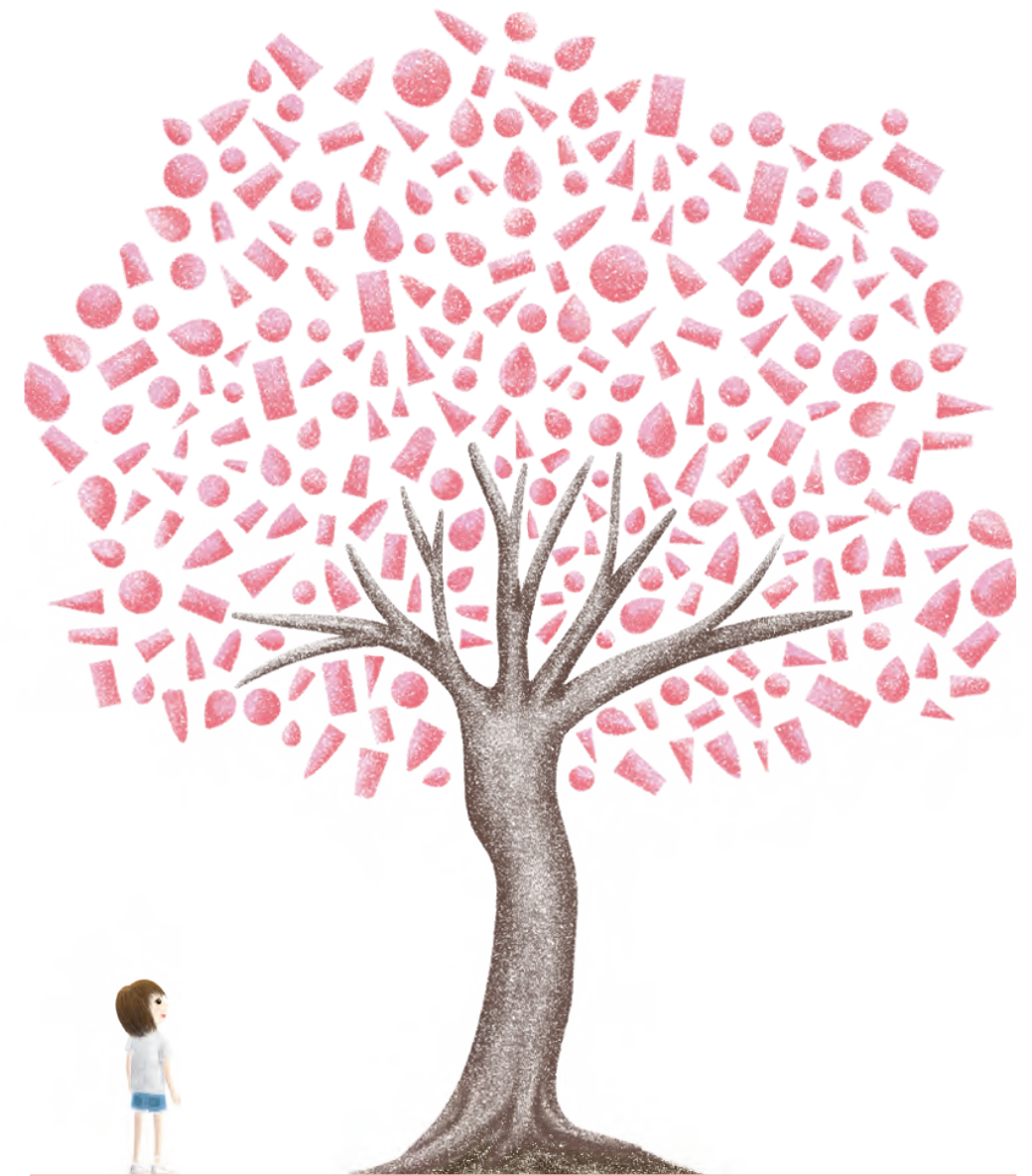

MIRACLE TOOLS

DiaMond Tools
 PolishIng Tools
 AiR tools
 cerAmic Fiber Stones
 ElectriC Grinders
 Ultrasonic PoLishers
 Diamond WheEls Grinding Tools

- 01** 水晶纖維油石
Cristone Crystal Fiber Stones
- 03** 犀利盾纖維油石
Ceraton Ceramic Fiber Stones
- 07** 鑽石纖維油石
Ceraton Ceramic Diamond Stones
- 08** 油石夾柄
Polishing Stone Holders
- 09** 水晶纖維油石刷
Cristone Bristles
- 17** Miracle 研磨油石
Miracle Polishing Stones

CONTENTS

目錄

- 23** 鑽石銼刀
Diamond Files
- 29** 鑽石及CBN砂輪
Diamond & CBN Wheels
- 33** 鑽石修刀
Diamond Dressers
- 36** 鑽石切片
Diamond Electroplated
Cutting Blades
- 37** 鑽石及CBN磨棒
Diamond & CBN Burrs
- 41** 鎢鋼滾磨刀
Solid Carbides

- 44** 鑽石油石
Diamond Polishing Stones
- 45** 線刷系列
Brushes
- 46** 氧化鋁帶柄砂輪
Aluminum Oxide Grinding Pins
- 47** 鑽石砂布
Diamond Foil & Diamond Cloth
- 48** 海綿及牛皮彈性帶柄砂輪
Sponge Elastic & Cow Leather
Grinding Pins
- 49** 大和海綿輪
Daiwa Rabin

- 51** 鑽石膏及鑽石微粉
Diamond Compounds
& Diamond Micron Powders
- 53** 羊毛輪
Felt Grinding Pins
- 55** 電動旋轉研磨機
Electric Rotaries
- 57** 超音波研磨裝置
Ultrasonic Polishers
- 59** 氣動旋轉研磨機、銼磨機
Air Grinders & Air Profiler-Linear
- 62** 大和碗型研磨輪 / 環狀研磨片
Daiwa Rabin Integral Cup Wheel
& Daiwa Rabin O Type Disk

水晶 纖維油石



Product details

Cristone Crystal Fiber Stones

Cristone 水晶纖維油石以強韌的水晶陶瓷纖維所製成，強度比一般的纖維油石提高一倍，適用於去除放電加工後 (EDM) 所產生的粗糙表面。高單位纖維含量以及整齊銳利的水晶纖維端面讓切削速度大幅度提升。

Cristone stands for Crystal Stone made from using the highest quality, chemically produced crystal fibers. The crystal line structure of the crystal fibers offers high polishing efficiency and incredible bending strength. Extremely strong for tight ribs and slots, excellent for EDM removal.

Cristone® Matrix

The Crystal nano Fiber Stones

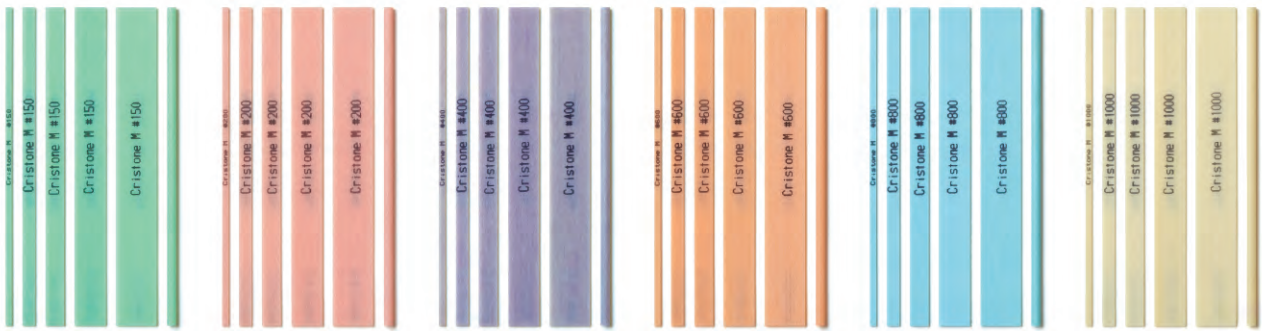

	1 x 2 x 100	1 x 4 x 100	1 x 6 x 100	1 x 10 x 100	1 x 13 x 100	Ø2.35 x 100	Ø3 x 100
#150 Green	JRG-0102100	JRG-0104100	JRG-0106100	JRG-0110100	JRG-0113100	JRG-0235100	JRG-03100
#200 Pink	JRP-0102100	JRP-0104100	JRP-0106100	JRP-0110100	JRP-0113100	JRP-0235100	JRP-03100
#400 Violet	JRV-0102100	JRV-0104100	JRV-0106100	JRV-0110100	JRV-0113100	JRV-0235100	JRV-03100
#600 Orange	JRO-0102100	JRO-0104100	JRO-0106100	JRO-0110100	JRO-0113100	JRO-0235100	JRO-03100
#800 Blue	JRB-0102100	JRB-0104100	JRB-0106100	JRB-0110100	JRB-0113100	JRB-0235100	JRB-03100
#1000 White	JRW-0102100	JRW-0104100	JRW-0106100	JRW-0110100	JRW-0113100	JRW-0235100	JRW-03100

我們建議將油石端面和工件夾角呈 30°~ 40° 的方式研磨，以得到最佳的切削性。

In order to reach the best performance, we recommend that the stone should be hold up-right making an angle of approx 30°~ 40° to the workpiece.

Cristone[®] Matrix

The Crystal nano Fiber Stones

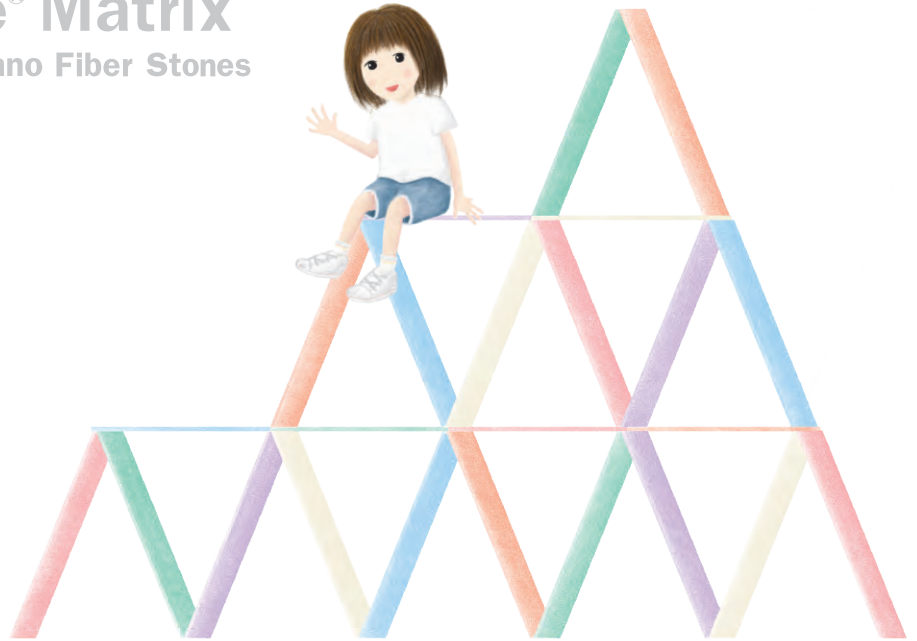

1 高強度 High strength
 抗折強度 1300MPa
 The highest bending strength 1300MPa.

2 高研磨力 High cutting performance
 研磨速度約提升 2 倍 (500mg 研磨時間縮短 50% · #400 使用實績)
 Polishing efficiency of ceramic stones 2 times up. (save 50% of removal EDM scale time)

3 平滑的切削面 High surface
 纖維構成面平整 · 研磨效果更佳 (Ra = 0.4μ 研磨時間縮短 50% · #400 使用實績)
 Optimal crystal line structure for polishing. (save 50% of cutting time to reach Ra = 0.4μ)

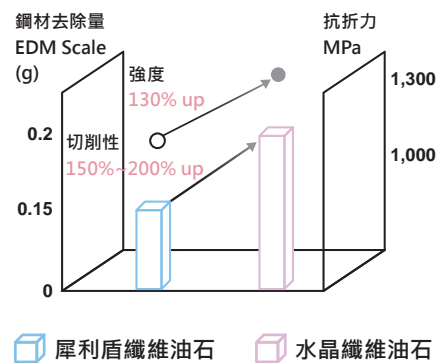
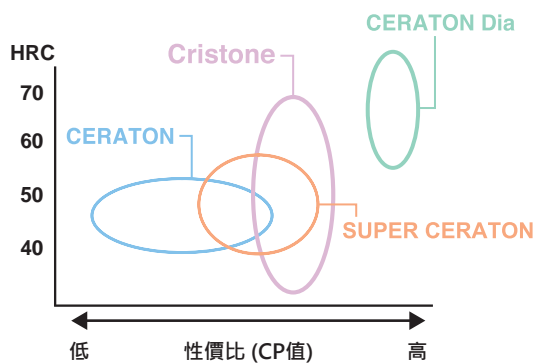

犀利盾 纖維油石



Product details

Ceraton Ceramic Fiber Stones

犀利盾纖維油石以強韌的陶瓷纖維結合樹脂所製成，與傳統油石相比具備更高強度的切削力及切削壽命。研磨效果優於傳統油石，且具備耐高熱、高彈性及不易塞穴的特性，適合使用於各類長時間連續加工機具。

CERATON is made from ceramic fibers bonded in thermosetting resins and exhibits superior strength, long life and no clogging compared to ordinary polishing stones. Suitable for all kinds of equipment like ultrasonic machines, air tools and also good by hand polishing.

CERATON® The Ceramic Fiber Stones



		1 x 4 x 100	1 x 6 x 100	1 x 10 x 100	Ø2.35 x 100	Ø3 x 100
#180 Brown		CSC1004	CSC1006	CSC1010	CGC235	CGC30
#250 Orange		CSO1004	CSO1006	CSO1010	CGO235	CGO30
#280 Black		CSD1004	CSD1006	CSD1010	CGD235	CGD30
#360 Navy Blue		CSN1004	CSN1006	CSN1010	CGN235	CGN30
#400 Blue		CSB1004	CSB1006	CSB1010	CGB235	CGB30
#500 Green		CSG1004	CSG1006	CSG1010	CGG235	CGG30
#700 Yellow		CSY1004	CSY1006	CSY1010	CGY235	CGY30
#1000 Pink		CSP1004	CSP1006	CSP1010	CGP235	CGP30
#1200 Red		CSR1004	CSR1006	CSR1010	CGR235	CGR30

超級犀利盾

纖維油石



Product details







Super Ceraton Ceramic Fiber Stones

超級犀利盾(SUPER CERATON)給您更強勁的切削效率·硬度更高·使用壽命更長·抗折力亦較佳。

SUPER CERATON provides more powerful cutting efficiency, higher hardness, longer using life, and stronger bending strength than CERATON.

SUPER CERATON®



		1 x 4 x 100	1 x 6 x 100	1 x 10 x 100
#120 Brown		CUSC1004	CUSC1006	CUSC1010
#220 Orange		CUSO1004	CUSO1006	CUSO1010
#400 Blue		CUSB1004	CUSB1006	CUSB1010
#800 Yellow		CUSY1004	CUSY1006	CUSY1010
#1000 White		CUSW1004	CUSW1006	CUSW1010
#1200 Red		CUSR1004	CUSR1006	CUSR1010

#120~#280	模具放電加工後之硬化表層去除及機械切削粗糙刀痕之去除 To remove the rough machining surface or hard EDM scale of tool & die steels.
#360~#500	細緻加工痕跡之去除及一般拋磨 General lapping and removal of delicate machining scratches.
#700~#1200	精細研磨或鏡面處理前之拋光 Fine polishing & finishing.
Ø3mm / Round	可搭配刻磨機當成研磨棒使用(長度勿超過 50mm 長)·或將其磨尖用於細緻角落、窄縫處等 It can use as grinding point (max. length 50mm), or by sharpening it for detail lapping.

迷你 水晶纖維油石



Product details

Cristone Mini Crystal Fiber Stones

水晶迷你纖維油石是纖維油石裁切成0.3 x 0.3mm ~ 0.9 x 0.9mm等微小尺寸，適用於凹縫、小溝槽等細部研磨。一般傳統油石裁成相同大小的尺寸容易產生斷裂的情形，水晶迷你纖維油石具高強度的韌性，是細部加工首選的研磨工具。

Mini Crystal Fiber Stones are cut by crystal fiber stones, including size from 0.3 x 0.3mm to 0.9 x 0.9mm, suitable for detail grinding such as recesses and small grooves. Traditional polishing stones are very fragile and cannot be cut to such a small size. With high strength toughness, it is the one of the best tools for detail polishing.

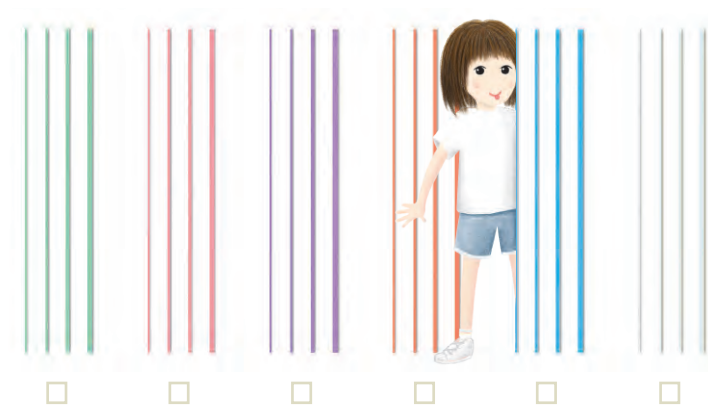

	0.3 x 0.3 x 100	0.5 x 0.5 x 100	0.7 x 0.7 x 100	0.9 x 0.9 x 100
#150 Green	JR150-0303100	JR150-0505100	JR150-0707100	JR150-0909100
#200 Pink	JR200-0303100	JR200-0505100	JR200-0707100	JR200-0909100
#400 Violet	JR400-0303100	JR400-0505100	JR400-0707100	JR400-0909100
#600 Orange	JR600-0303100	JR600-0505100	JR600-0707100	JR600-0909100
#800 Blue	JR800-0303100	JR800-0505100	JR800-0707100	JR800-0909100
#1000 White	JR1000-0303100	JR1000-0505100	JR1000-0707100	JR1000-0909100
油石夾柄 Holder	XH-005	XH-007	XH-009	XH-013

單一尺寸，粒度最小訂購量 10 支 / 盒。

MOQ : 10 pcs / box per grit size or multiples.

犀利盾纖維油石
迷你



Product details

Ceraton Mini Ceramic Fiber Stones

犀利盾迷你纖維油石是將纖維油石切成細微尺寸，從 0.3 x 0.3 mm ~ 1 x 2 mm。專門使用於各種模具之細微部位或是其它類似之加工，由於陶瓷纖維具有高抗折強度，可解決一般油石易斷之困擾。

Mini Ceraton fiber stone is an excellent stone for EDM removal and is suitable for detail polishing on all types of molds, especially for engraving parts, slight ribs, radius ribs, corners and complicated area.

CERATON® The Mini Ceramic Fiber Stones

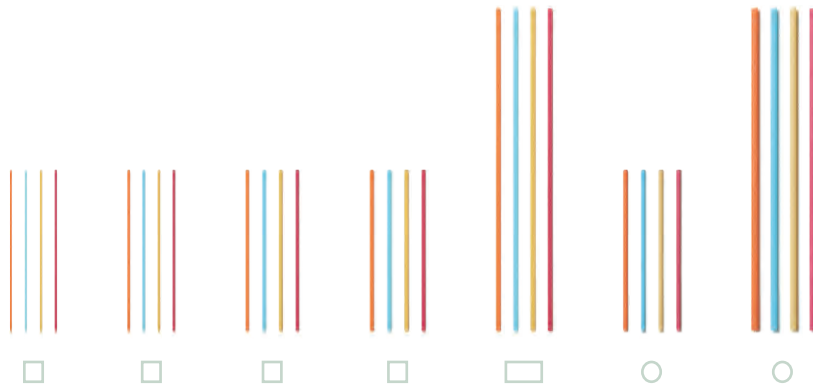

	0.3 x 0.3 x 50	0.5 x 0.5 x 50	0.7 x 0.7 x 50	0.9 x 0.9 x 50	1.0 x 2.0 x 100	Ø0.9 x 50	Ø2.0 x 100
#250 Orange	JMOS-035	JMOS-055	JMOS-075	JMOS-095	JMOS-121	JMOG-105	JMOG-201
#400 Blue	JMBS-035	JMBS-055	JMBS-075	JMBS-095	JMBS-121	JMBG-105	JMBG-201
#700 Yellow	JMYS-035	JMYS-055	JMYS-075	JMYS-095	JMYS-121	JMYG-105	JMYG-201
#1200 Red	JMRS-035	JMRS-055	JMRS-075	JMRS-095	JMRS-121	JMRG-105	JMRG-201
油石夾柄 Holder	XH-005	XH-007	XH-009	XH-013	XH-200	XH-009	XH-200

鑽石纖維油石



Product details

Ceraton Ceramic Diamond Stones

以獨家技術結合陶瓷纖維及鑽石研磨顆粒，再搭配強韌的樹脂所製成此款鑽石纖維油石。加入鑽石研磨粉後，除了大幅的提昇纖維油石的切削性，也同時縮短了加工的時程，適用於各類較高硬度的工件。

Ceramic diamond stones are made of diamond abrasives and ceramic fibers bonded together with thermosetting resins. The combination of diamond and ceramic fibers creates the outstanding cutting performance. Ceramic diamond stone is a perfect lapping tool for higher hardness material such as tungsten carbide.

CERATON® The Ceramic Diamond Stones



- 1 一般纖維油石的切削性來自於油石的端面，但鑽石纖維油石各部位如平面、側邊或先端皆可使用。Ceramic diamond stones on any sides or ends have cutting force, while ordinary ceramic fiber stones only have cutting force at its end.
- 2 一般傳統油石無法加工如超硬度模具等許多特殊材質的模具，但鑽石纖維油石無此限制。Hard materials, those are difficult to be ground by ordinary ceramic stone, now the ceramic diamond stone can provide a much better cut.
- 3 鑽石纖維油石可用於各類加工如：EDM 放電後表面研磨、鑄鋼模具拋光、陶瓷加工及玻璃表面研磨等。Ceramic diamond stone is suitable for lapping all kinds of hardened steels, EDM surface, tungsten carbides, ceramics and glass efficiently.

		1 x 4 x 100	1 x 6 x 100	1 x 10 x 100	Ø3 x 100
#200 Black		CDS1004-200	CDS1006-200	CDS1010-200	CDS30-200
#400 Gray		CDS1004-400	CDS1006-400	CDS1010-400	CDS30-400
#600 Moss Green		CDS1004-600	CDS1006-600	CDS1010-600	CDS30-600
#800 Green		CDS1004-800	CDS1006-800	CDS1010-800	CDS30-800

油石 夾柄

Polishing Stone Holders

款式多樣，可搭配各尺寸油石，讓您手持研磨拋光時更加得心應手。

Various types suit different sizes of polishing stones. Make your working more efficiently.



Product details



可夾持形狀 Holding Capacity	平形 Flat	平形 Flat	平形 Flat	平形 Flat	平形 Flat	平形 Flat
尺寸 Size	4 x 1	6 x 1	10 x 1	6 x 2 or 6 x 3	13 x 3	13 x 6.3
運用 Applications	纖維油石 Fiber stone	纖維油石 Fiber stone	纖維油石 Fiber stone	一般油石 Polishing stone	一般油石 Polishing stone	一般油石 Polishing stone



可夾持形狀 Holding Capacity	方形或圓形 Square or Round	方形或圓形 Square or Round	方形或圓形 Square or Round	方形 Square	平形或圓形 Flat or Round	圓形 Round	平形或圓形 Flat or Round
尺寸 Size	0.3 x 0.3 or Ø0.5	0.5 x 0.5 or Ø0.7	0.7 x 0.7 or Ø0.9	0.9 x 0.9	2 x 1 or Ø2.0	Ø3.0	T=1mm or Ø3.0
運用 Applications	迷你纖維油石 Mini fiber stone	迷你纖維油石 Mini fiber stone	迷你纖維油石 Mini fiber stone	迷你纖維油石 Mini fiber stone	迷你纖維油石 Mini fiber stone	纖維油石 Fiber stone	機械用銼刀 彈性銼刀片 Machine taper diamond files / Flexible files

碗型 水晶纖維油石刷



Product details

Cristone Bristles

Cup Type

高密度的水晶纖維油石所製成，具備高切削力、穩定的加工能力且低磨耗，適用於自動化去毛邊與研磨。

Made of high-density Crystal Fiber Stones. Excellent cutting performance, stable processing ability, and low abrasion. Suitable for deburring and grinding on automation equipment.



Size=DxLxd	#150 Green	#200 Pink	#400 Violet	#600 Orange	#800 Blue	#1000 White	#1200 Red
Ø6 x 30L x Ø8	CB31G-00630	CB31P-00630	CB31V-00630	CB31O-00630	CB31B-00630	CB31W-00630	CB31R-00630
Ø15 x 50L x Ø6	CB31G-01550	CB31P-01550	CB31V-01550	CB31O-01550	CB31B-01550	CB31W-01550	CB31R-01550
Ø25 x 75L x Ø9	CB31G-02575	CB31P-02575	CB31V-02575	CB31O-02575	CB31B-02575	CB31W-02575	CB31R-02575
Ø40 x 75L x Ø12	CB31G-04075	CB31P-04075	CB31V-04075	CB31O-04075	CB31B-04075	CB31W-04075	CB31R-04075
Ø60 x 75L x Ø13	CB31G-06075	CB31P-06075	CB31V-06075	CB31O-06075	CB31B-06075	CB31W-06075	CB31R-06075
Ø100 x 75L x Ø17	CB31G-10075	CB31P-10075	CB31V-10075	CB31O-10075	CB31B-10075	CB31W-10075	CB31R-10075

若對線材長度有特殊要求，以10mm為一單位增加，請備註完整。

Custom-made length of Cristone Bristles is available by increasing or reducing each 10mm.

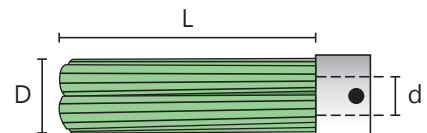

油石刷夾柄

Holder

型號 Model	尺寸 Size D x L x L ₁ x d (mm)	適用油石刷尺寸 Cristone Bristle Size
XH-CB006	Ø10 x 70 x 30 x Ø6	Ø6
XH-CB015	Ø18.5 x 90 x 30 x Ø6	Ø15
XH-CB025	Ø30 x 140 x 30 x Ø10	Ø25
XH-CB040	Ø45 x 140 x 30 x Ø12	Ø40
XH-CB060	Ø65 x 150 x 35 x Ø12	Ø60
XH-CB100	Ø110 x 162 x 40 x Ø16	Ø100

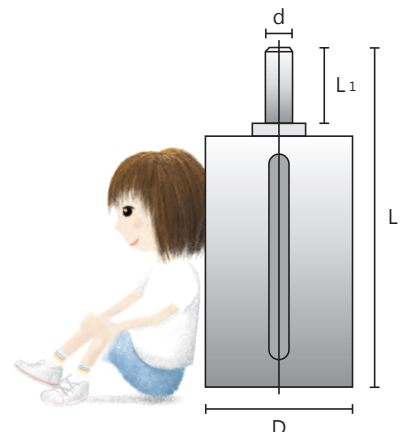

使用方法 Way to set up



1. 將纖維油石刷置入夾柄內。
To set fiber brush into the holder.

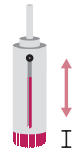

2. 調整刷子的突出長度。
Adjust the length of the fiber brush.



3. 將螺絲固定在溝槽上。
Fix bolts into the slits.

注意事項 Attention

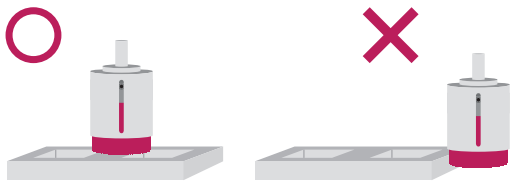

請使用油石刷的末端進行研磨，因為側邊並不具備研磨能力。
Please use the tip of the fiber brush for grinding, because the side of the fiber brush does not have grinding force.

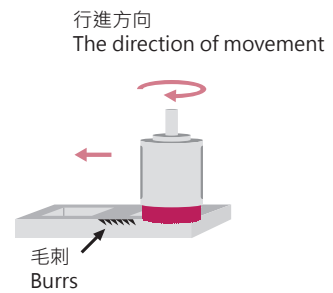

油石刷行進方向與毛刺的方向相反，研磨效果較佳。
To remove burrs on the edge, the Cristone Bristle needs to go the opposite direction of burrs. It gets more efficient removing / polishing result.

關於毛刺 About burrs

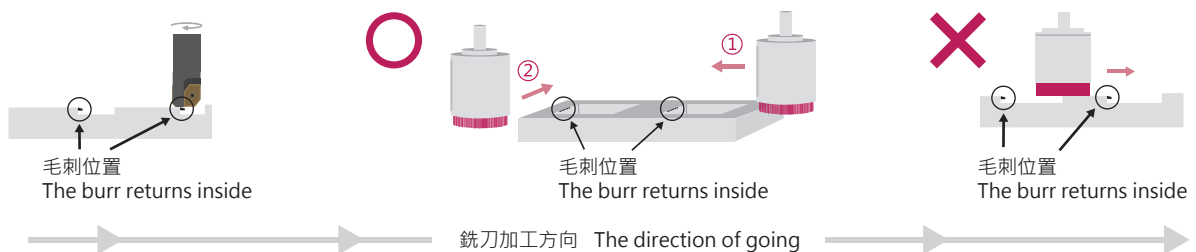

銑刀加工後，毛刺會出現在加工溝槽的側邊。
After processing precision machining, the burrs will occur on the side of the slit.

纖維油石刷研磨方向應與銑刀加工方向相反(如①)，或與銑刀加工方向成90°(如②)。
Process the fiber brushes to the direction ① or ② which face the burrs directly.

纖維油石刷與銑刀加工方向相同時，毛刺會被掃進溝槽中無法清除。
After proceeding in one direction, the burrs will occur inside the slit.

帶柄 水晶纖維油石刷



Product details

Cristone Bristles

End Type

由多支水晶纖維油石製成的帶柄纖維刷，其切削力、使用壽命以及柔軟度更優於一般刷子，能夠有效地去除表面粗糙，適用於電動、氣動等研磨工具。

The mounted fiber brush is made of multiple Crystal Fiber Stones, with better cutting performance and durability, which can effectively remove surface roughness and avoid excessive cutting. Suitable for grinders, like electric rotaries and air tools.

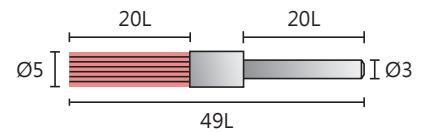

Maximum speed 12000min⁻¹ rpm

#150
Green

#200
Pink

#400
Violet

#600
Orange

#800
Blue

#1000
White

#1200
Red

型號 Model

CBRG-0520-3

CBRP-0520-3

CBRV-0520-3

CBRO-0520-3

CBRB-0520-3

CBRW-0520-3

CBRR-0520-3

加工範例 Processing examples

車用零件
The parts of automobile

工件：ADC12
Workpiece: ADC12

S 6000 min⁻¹
F 1000 mm / min
D 0.5 mm

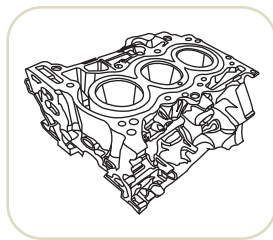

油石刷前端的形狀可藉由在鑽石砂布研磨後，改變刷頭形狀，因此能適用於各種不同種類之工件上。

If you want to make angle on the tip of the brush, turn the brush and shape it by touching the diamond foils and files. By doing this, you can easily dress a tool.

飛機零件
The parts of air craft

工件：鋁合金
Workpiece: Aluminum alloy

S 6000 min⁻¹
F 1000 mm / min
D 0.5 mm

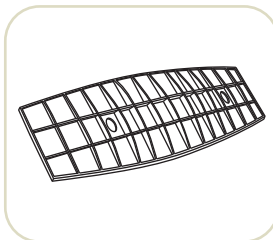

水晶纖維油石刷 筆型



Product details

Cristone Bristles

Pen Type

水晶纖維油石刷筆芯，需搭配夾柄使用，針對細部雕刻、溝縫、R角等...複雜部位的研磨。

Pen type brush for use with a pen holder. Excellent performance on detailed carvings, slot, radius etc.

夾柄
Holder



芯
Lead



	#150 Green	#200 Pink	#400 Violet	#600 Orange	#800 Blue	#1000 White	#1200 Red
Cristone Bristle Pen set 筆+芯 (holder+lead)	CBP33G-0208S	CBP33P-0208S	CBP33V-0208S	CBP33O-0208S	CBP33B-0208S	CBP33W-0208S	CBP33R-0208S
Cristone Bristle Pen 芯 (lead)	CBP33G-020080	CBP33P-020080	CBP33V-020080	CBP33O-020080	CBP33B-020080	CBP33W-020080	CBP33R-020080
夾柄 Holder	XH - 200	XH - 200	XH - 200	XH - 200	XH - 200	XH - 200	XH - 200

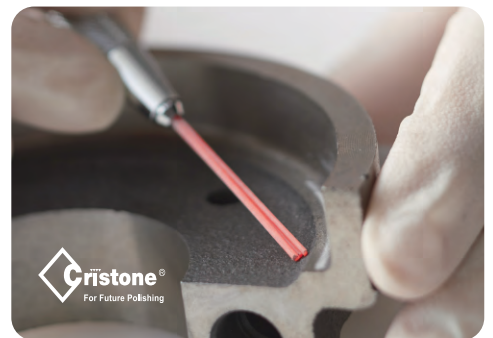
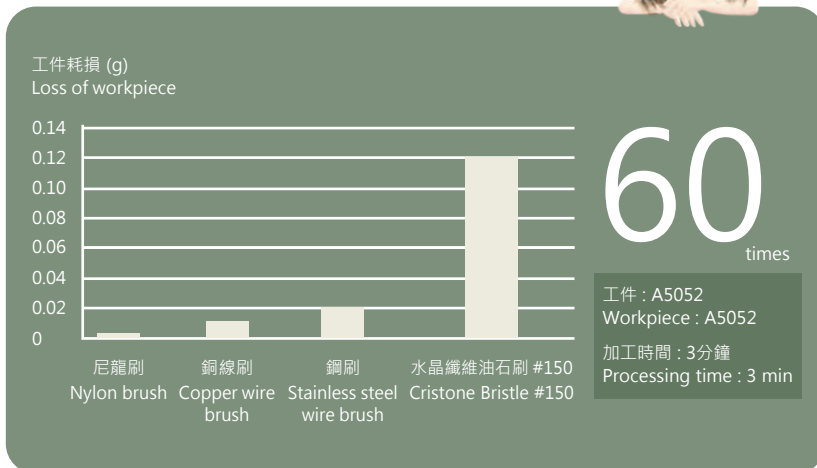

筆型水晶纖維油石刷可自由調節長度。
Cristone Bristle pen type can adjust the length by knocking the holder.

水晶纖維油石刷與帶磨粒的尼龍刷相比，具有高約 60 倍的研磨效率。
"Cristone Bristle" achieves 60 times the grinding performance of nylon brushes with abrasive grain.

內孔 水晶纖維油石刷



Product details

Cristone Bristles

Cross hole brush

透過旋轉產生的離心力來展開油石刷，去除內孔側面、底部毛邊。適用於電動、氣動、CNC等研磨工具。

Bristles of cross hole brush are spread by the centrifugal force generated during rotation to remove burrs on sides and bottom of an inner hole. Suitable for electric grinders, air grinders or CNC.

S 形狀
Type

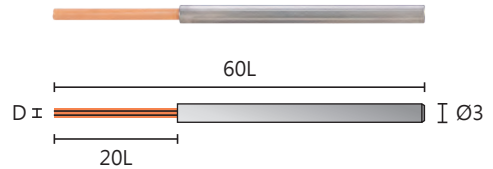

Maximum speed 14000min⁻¹ rpm

Size=D	#150 Green	#200 Pink	#400 Violet	#600 Orange	#800 Blue	#1000 White	#1200 Red
Ø1	CB31G-S-010020	CB31P-S-010020	CB31V-S-010020	CB31O-S-010020	CB31B-S-010020	CB31W-S-010020	CB31R-S-010020
Ø1.5	CB31G-S-015020	CB31P-S-015020	CB31V-S-015020	CB31O-S-015020	CB31B-S-015020	CB31W-S-015020	CB31R-S-015020
Ø2	CB31G-S-020020	CB31P-S-020020	CB31V-S-020020	CB31O-S-020020	CB31B-S-020020	CB31W-S-020020	CB31R-S-020020
Ø2.5	CB31G-S-025020	CB31P-S-025020	CB31V-S-025020	CB31O-S-025020	CB31B-S-025020	CB31W-S-025020	CB31R-S-025020
Ø3	CB31G-S-030020	CB31P-S-030020	CB31V-S-030020	CB31O-S-030020	CB31B-S-030020	CB31W-S-030020	CB31R-S-030020

Ø1mm的內孔型油石刷只帶1根油石纖維，因此操作時不會散開。請從最低轉速緩慢調高且不要超過最大限速的14,000轉，以免轉速過快而斷裂。
1 mm brush is with one piece of ceramic fiber bristle as circled, so the brush will not spread out while rotation. Please increase the speed from the lowest slowly and do not exceed the maximum limit of 14,000 rpm to avoid the damage.

加工範例 Processing examples

工件：鋁管
Workpiece : Aluminum pipe
工具：內孔研磨刷 Ø5 #1000
Tool : Cross hole brush Ø5 #1000
轉速：S 11000 min⁻¹ rpm

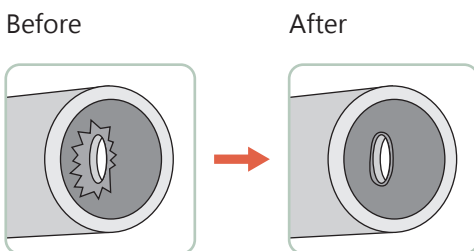

透過旋轉時產生的離心力來展開油石刷，去除內孔側面、底部的毛邊。

Ceramic fiber brush removes burrs by extending the brush rotation. You can remove the burrs of the side and the bottom of the radius cross hole.

M 形狀
Type

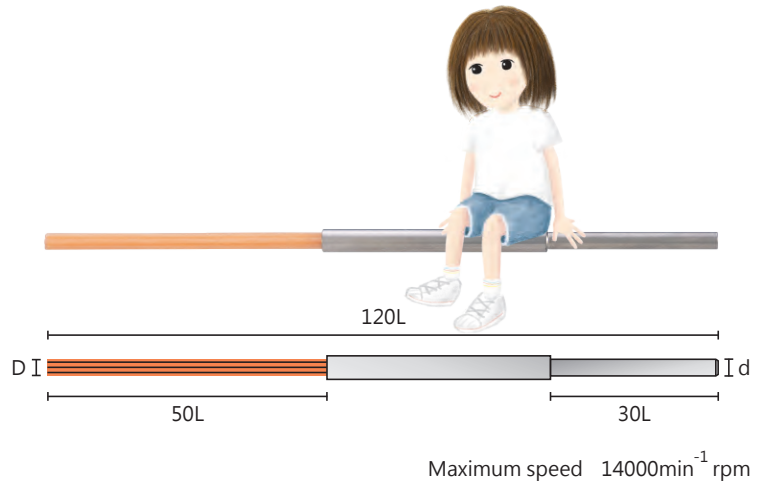

Maximum speed 14000min⁻¹ rpm

Size=Dxd	#150 Green	#200 Pink	#400 Violet	#600 Orange	#800 Blue	#1000 White	#1200 Red
Ø3 x Ø3	CB31G-M-03050	CB31P-M-03050	CB31V-M-03050	CB31O-M-03050	CB31B-M-03050	CB31W-M-03050	CB31R-M-03050
Ø5 x Ø6	CB31G-M-05050	CB31P-M-05050	CB31V-M-05050	CB31O-M-05050	CB31B-M-05050	CB31W-M-05050	CB31R-M-05050
Ø7 x Ø6	CB31G-M-07050	CB31P-M-07050	CB31V-M-07050	CB31O-M-07050	CB31B-M-07050	CB31W-M-07050	CB31R-M-07050

若對線材長度有特殊要求，以10mm為一單位增加，請備註完整。

Custom-made length of Cristone Bristles is available by increasing or reducing each 10mm.

注意事項 Attention

1. 在進入孔內前不要旋轉油石刷。

Do not rotate till you reach the cross hole.



2. 調整轉速後使刷子接觸毛邊，並前後移動油石刷。

Adjust the rotation of the fiber brush to touch the burrs. Process the fiber brush forward and back.

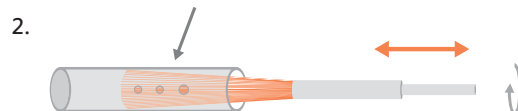

3. 務必確認油石刷已停止轉動，再將其取出，若是在轉動時取出，有可能因為油石刷斷裂而造成危險。

It is very dangerous when you rotate the brush outside of the hole as it might break. Please make sure to stop the rotation before pulling out the fiber brush from the hole.

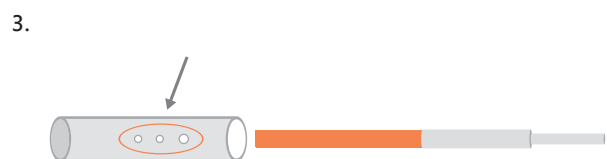

手持 水晶纖維油石刷



Product details

Cristone Bristles

Broom Type

手持式油石刷可針對工件的不同曲面做研磨，適用於粗加工到半精加工。如去除刀痕或放電加工後的硬化層。

Broom type can better touch the curved workpiece surface, increasing the grinding area to improve the efficiency.

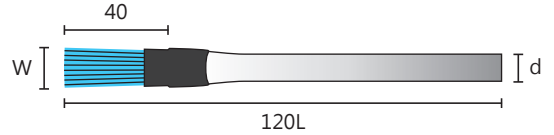

Size=Wxd	#150 Green	#200 Pink	#400 Violet	#600 Orange	#800 Blue	#1000 White	#1200 Red
6 x Ø5	CBF33G-0640	CBF33P-0640	CBF33V-0640	CBF33O-0640	CBF33B-0640	CBF33W-0640	CBF33R-0640
9 x Ø6	CBF33G-0940	CBF33P-0940	CBF33V-0940	CBF33O-0940	CBF33B-0940	CBF33W-0940	CBF33R-0940
16 x Ø10	CBF33G-1640	CBF33P-1640	CBF33V-1640	CBF33O-1640	CBF33B-1640	CBF33W-1640	CBF33R-1640

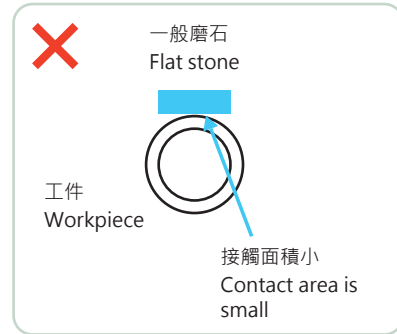
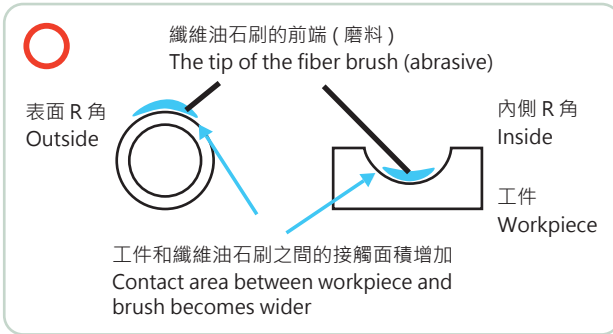

一般磨石因為接觸面積小，需藉由砂布等工具輔助才能達到有效的研磨，但對於手持式油石刷來說，因其個別的細小油石可獨立地觸及工件表面，使得接觸面積大增，研磨效率亦隨之提升。

For small contact area, the flat type stone is unable to polish. Broom type bristles are more likely to contact the workpiece over a large area, especially curved or 3D shapes.



對於不規則形狀之工件有良好的研磨效果。

Cristone Bristle is useful to process for curve and 3D shape.

水晶纖維研磨片



Cristone Disc

專為電動工具設計的水晶纖維研磨片，0.8mm的厚度適用於底部、溝槽的拋光及切割。

Cristone Disc is the unique nano fiber structure ceramic grinding wheel. The thickness 0.8mm issuitable for polishing the rib bottom, thin groove and also cutting.

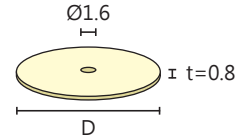

Maximum speed 15000min⁻¹ rpm

Size=D	#150 Green	#200 Pink	#400 Violet	#600 Orange	#800 Blue	#1000 White
Ø13	JR150MW-08013	JR200MW-08013	JR400MW-08013	JR600MW-08013	JR800MW-08013	JR1000MW-08013
Ø19	JR150MW-08019	JR200MW-08019	JR400MW-08019	JR600MW-08019	JR800MW-08019	JR1000MW-08019
Ø22	JR150MW-08022	JR200MW-08022	JR400MW-08022	JR600MW-08022	JR800MW-08022	JR1000MW-08022
Ø25	JR150MW-08025	JR200MW-08025	JR400MW-08025	JR600MW-08025	JR800MW-08025	JR1000MW-08025
Ø30	JR150MW-08030	JR200MW-08030	JR400MW-08030	JR600MW-08030	JR800MW-08030	JR1000MW-08030

相關工具

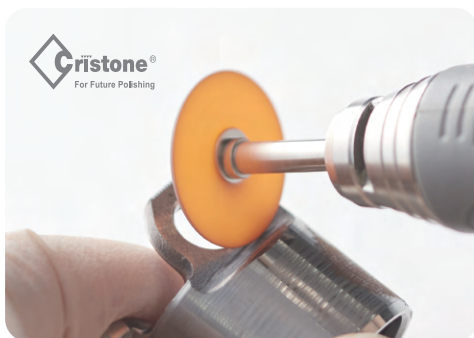
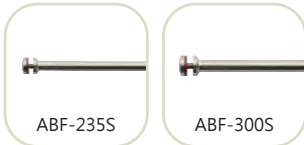

專為電動工具設計的水晶纖維研磨片，不適用於氣動工具。

Designed for electric rotary tools, not suitable for pneumatic tools.





Product details

Miracle Polishing Stones

製造於日本的 Miracle Polishing Stones 是模具用研磨油石，其優秀的研磨粒子可保持優異的穩定性且不損壞加工材料表面，可迅速消除放電加工後的凹凸面及斑點，具有優秀的切削性能。

Miracle Polishing Stones are made in Japan or U.S. for tooling. The excellent grains are for maintaining the stability, less abrasion, shortening machining time, removing layer after EDM processing, and showing outstanding cutting performance.

磨料種類及用途

Selection of Abrasive Formula

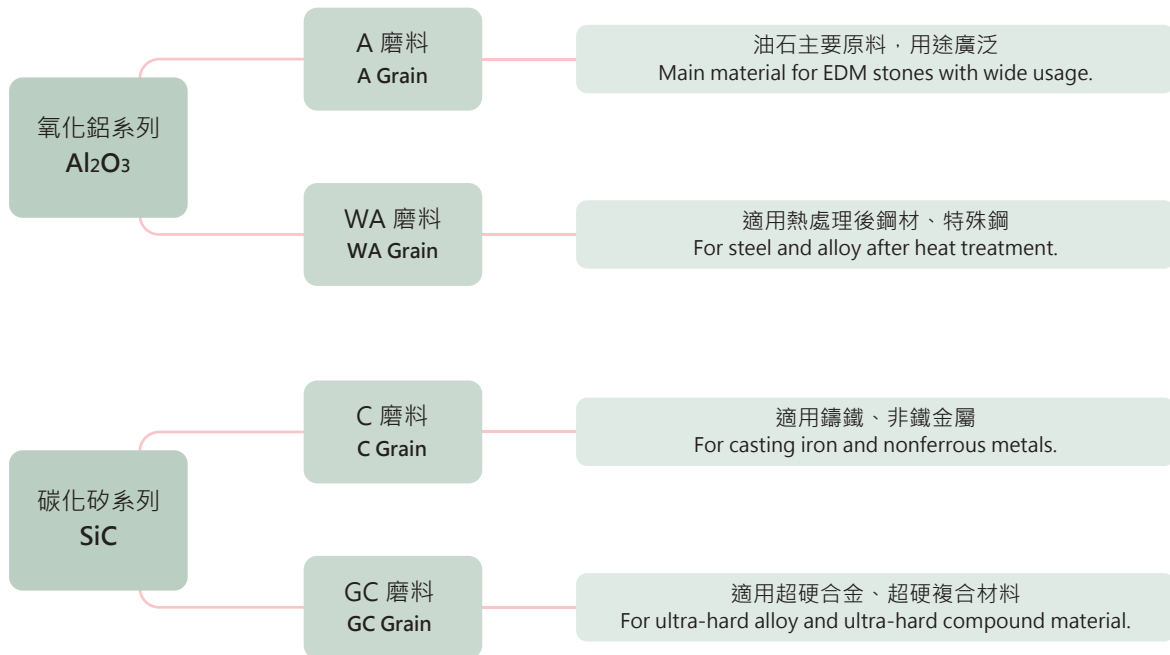

單一尺寸、粒度之最小訂購量

Minimum order per size & grit

10pcs / box (盒)

3x13x100 3x13x150 5x13x150 6x6x150 6x13x150

20pcs / box (盒)

1x10x100 3x3x150 3x6x100 3x6x150 4x4x150



產品名稱 (Description)	磨料 (Grain)	結合劑 (Bond)	硬度 (Hardness)	模具種類 Mold				適用材質 Metal Worked				研磨用途 Polishing Usage				研磨方法 Polishing Method	
				塑膠模 (Plastic mold)	鑄鐵模 (Die casting mold)	橡膠模 (Rubber mold)	壓鑄模 (Press mold)	較硬材質金屬 (Hard metals)	較軟材質金屬 (Soft metals)	一般金屬 (General metals)	鋁 (Aluminum)	粗加工 (Rough Finishing)	普通加工 (Medium Finishing)	精加工 (Fine Finishing)	放電加工後 (After EDM)	乾式研磨 (Dry)	濕式研磨 (Wet)
VH	VH	V	中硬 MH	●		●		●	●	●			●		●		●
AR			超硬 SH				●	●	●				●		●		●
INDIA	A	V	硬 H				●	●	●	●			●		●		●
EDM-BL	WA	V	硬 H	●		●		●		●			●	●		●	●
EDM-BR	WA	V	中硬 MH	●	●	●		●		●			●	●		●	●
BLK	C	V	中軟 MS		●	●	●	●	●	●			●	●	●		●
GC	GC	V	中軟 MS		●	●	●	●	●	●			●	●	●		●
DIE	A	V	中軟 MS			●		●		●			●			●	●
SO	WA	V	中硬 MH	●	●	●	●			●	●		●	●	●	●	●

結合劑 - V: 使用 1200~1350°C 高溫製成，耐水性及抗藥性佳、容易保存，可長期放置不易變質且用途廣泛，為製造傳統油石歷史最悠久的材料。

硬度表示: 超硬 - 硬 - 中硬 - 中 - 中軟 - 軟

Bond - V: Made through 1200~1350°C high temperature. It has the features such as water resistant, chemical liquid resistant, material stable to store easier and wide usage. It is the best and the most traditional material for manufacturing polishing stones.

Hardness: SH (Super Hard) - H (Hard) - MH (Medium Hard) - M (Medium) - MS (Medium Soft) - S (Soft)

VH 放電油石 (Made in USA)
(GOLDEN STONE)



硬度 Hardness		粒 度 Grit Size				尺 寸 Size	
中硬 MH						3x3x150	3x13x150
磨料 Grain	結合劑 Bound	#150	#180	#240	#400	4x4x150	6x6x150
VH	V	#600	#1200	#1500	#2500	3x6x150	6x13x150

用途：放電加工後的表面處理及優異的銑刀加工痕跡去除性。

性能：以優質氧化鋁顆粒和專有處理工藝製成，在 EDM 表面、銑削和機械加工痕跡上表現優異，能快速去除工件痕跡且留下絲滑般的質感。適用手持夾柄和往覆式研磨機。

Application : Delivering exceptional performance on EDM surfaces and machining marks.

Features : Made with premium aluminum oxide grain and a proprietary treatment process, VH stone delivers exceptional performance on EDM surfaces, milling and machining marks. It contours quickly and leaves a silky smooth finish. Suitable for hand holders and reciprocating profilers.

訂購代號：PS-VH-33150(尺寸)-150(粒度) Order No. : PS-VH-33150(Size)-150(Grit)

AR 阿肯色油石
(ARKANSAS STONE)



硬度 Hardness	平形 flat ■		三角 triangle ▲	方形 square ■	圓形 circle ●
	超硬 SH	6x25x50	16x38x115	3.2x3.2x100	
	9.5x25x75	25x50x150	4.5x4.5x100		4.5x100
	13x25x100	25x50x200	6.4x6.4x100		6.4x100
			13x13x100		8.0x100
					13x100

用途：刀具和硬質材料。

性能：僅產於美國的天然石材，具備高密度及超硬組織。適用於手錶、儀表等精細加工。

Application : Cutlery and hard materials.

Features : This natural stone is produced only in the United States and has highly dense and ultra hard tissue. It is suitable for ultra fine finishing of watch, gauge and precision machinery.

訂購代號：PS-ARKANSAS-1325100(尺寸) Order No. : PS-ARKANSAS-1325100(Size)

INDIA 印度油石
(INDIA STONE)



硬度 Hardness		粒 度 Grit Size		平形 flat ■	三角 triangle ▲	方形 square ■
硬 H				6x25x100	3.2x3.2x100	
磨料 Grain	結合劑 Bound	FB 細目 / (Fine)		9.5x25x75	4.5x4.5x100	
A	V	MB 中目 / (Medium)		13x25x100	6.4x6.4x100	
				25x50x150	8.0x8.0x100	
				25x50x200	9.5x9.5x100	

用途：適用於各種刀具。

性能：產地為美國，擁有豐富的油脂含量。適合各種刀具及工具的修整。

Application : Cutlery and all kinds of tools

Features : This stone, originally conveyed from the United States, contains rich oil and has sharp breaking ability. It is good for setting cutlery and finishing for various kinds of tools.

訂購代號：PS-INDIA-1325100(尺寸)-FB(粒度) Order No. : PS-INDIA-1325100(Size)-FB(Grit)

EDM-BL
(EDM STONE)



硬度 Hardness		粒度 Grit Size	尺寸 Size	
硬 H		#120 #180 #240 #320 #400 #600 #800 #1000 #1200	1x10x100	3x13x150
磨料 Grain	結合劑 Bound		3x6x100	5x13x150
WA	V		3x6x150	6x6x150

用途：一般模具及放電加工後的表面研磨。

性能：可輕易去除 EDM 後表面頑固的吸附粒子，且不傷及模具表層。對於銳角及角落的細部研磨具有非常顯著的效果。

Application : Surface polishing for EDM processing and general mold.

Features : This special stone has higher hardness and less abrasion. It shows excellent performance for detailed polish, such as corners of acute angles.

訂購代號：PS-EDM-BL36150(尺寸)-120(粒度) Order No. : PS-EDM-BL36150(Size)-120(Grit)

EDM-BR
(LAP MATE EDM STONE)



硬度 Hardness		粒度 Grit Size	尺寸 Size	
中硬 MH		#120 #180 #240 #320 #400 #600 #800 #1000 #1200	1x10x100	3x13x150
磨料 Grain	結合劑 Bound		3x6x100	5x13x150
WA	V		3x6x150	6x6x150

用途：一般模具、鑄鐵模及放電加工後的表面研磨。

性能：由高密度且耐磨 WA 磨粒經由特殊樹脂加工而成。具有良好的切削力且磨損較小，不易因磨削而變形。適用於細部研磨、粗加工到半精加工的修飾

Application : Surface polishing for EDM processing, die casting mold and general mold.

Features : EDM BR stone is manufactured from high-density and wear-resistant WA grains with special resin treatment. The stone holds its shape and has great cutting performance at a low removal rate. Suitable for detail polishing, roughing and semi-finishing.

訂購代號：PS-EDM-BR36150(尺寸)-120(粒度) Order No. : PS-EDM-BR36150(Size)-120(Grit)

SO
(SUPER ORANGE STONE)



硬度 Hardness		粒度 Grit Size	尺寸 Size	
中硬 MH		#120 #180 #220 #320 #400 #600	3x6x150	5x13x150
磨料 Grain	結合劑 Bound		3x13x150	6x6x150
WA	V			

用途：搭配使用往覆式氣動研磨機，超音波研磨機效果更佳。

性能：特別設計用於往覆式氣動工具及超音波研磨機，特殊橘色 WA 砥粒除了不易折斷的特性，更可維持研磨先端的鋒利，最適合用在 EDM 加工後硬化層附著物的去除。

Application : Surface lapping after EDM processing. Use with profiler-linear.

Features : SO stone is for removing hardened layer after EDM processing. This stone is not easy to break, so it can use with air profiler-linears and ultrasonic polishers. It can keep sharply by avoiding grains to drop out.

訂購代號：PS-SO-36150(尺寸)-120(粒度) Order No. : PS-SO-36150(Size)-120(Grit)

BLK
(BLACK STONE)



硬度 Hardness		粒度 Grit Size		尺寸 Size	
中軟 MS		#120 #180 #240 #320 #400 #600 #800 #1000 #1200 #1500 #2000 #3000		3x6x100	3x13x150
磨料 Grain	結合劑 Bound			3x6x150	5x13x150
C	V				

用途：一般模具及硬質材料模具等。

性能：細緻、鋒利的研磨端，能迅速將模具細部完整加工。中軟硬度的 SIC 砥粒，適用於高標準要求的模具鏡面細部之修飾。同時也適用於硬質材料模具的研磨。

Application : General mold and hard material mold.

Features : This stone is made of medium soft SIC grains with sharp points designed to swiftly fit to detail forms of molds. It is suitable for operation before diamond paste processing, mold which needs fine finishing, or hard material mold.

訂購代號：PS-BLK-36150(尺寸)-120(粒度) Order No. : PS-BLK-36150(Size)-120(Grit)

GC
(GC STONE)



硬度 Hardness		粒度 Grit Size		尺寸 Size	
中軟 MS		#120 #180 #240 #320 #400 #600 #800 #1000 #1200 #1500 #2000 #3000		3x6x100	3x13x150
磨料 Grain	結合劑 Bound			3x6x150	5x13x150
GC	V			3x13x100	

用途：一般模具及非鐵金屬，硬質工具等。

性能：綠色 SIC 砥粒加上特殊結合劑的完美結合，製作出專門針對細部修飾及拋光的 GC STONE，不只能安穩地處理表層細微的紋路，更可用在超硬熱處理的鋼材修飾上。

Application : General mold, nonferrous metal and hard material tool.

Features : With green SIC grains mixed among special bond. This stone does not damage surface but give stable finishing. It is suitable for carbide and quenched steels.

訂購代號：PS-GC-36150(尺寸)-120(粒度) Order No. : PS-GC-36150(Size)-120(Grit)

DIE
(DIE STONE)



硬度 Hardness		粒度 Grit Size		尺寸 Size	
中軟 MS		#150 #180 #220 #320 #400 #600		3x6x150	5x13x150
磨料 Grain	結合劑 Bound			3x13x150	6x6x150
A	V				

用途：淬鋼合金之表面研磨，針對 HRC47~63 硬度模具表現更為優秀。

性能：在硬度範圍 HRC47~63 的鋼材表面研磨上會有最佳的表現。超銳利的A級砥粒亦可用於切割，更適合硬質材料的研磨。

Application : Surface polishing for quenched steel of HRC 47 to 63.

Features : DIE stone is for quenched steel of HRC 47 to 63. Medium soft hardness of this stone provides an excellent finishing and the sharp cutting of A grains enables polishing for hardened materials.

訂購代號：PS-DIE-36150(尺寸)-150(粒度) Order No. : PS-DIE-36150(Size)-150(Grit)

大和 WA 橡膠油石



Product details

Daiwa-Stick

具備彈性橡膠材質，可輕易達到全面的均勻研磨，且不易造成明顯痕跡。可放心地在鋁材表面研磨且耐用度佳，完美取代傳統油石及砂紙，成為您的得力助手。

Benefited from DAIWA RABIN's elastic rubber, it is easy to grind all over the surface of a workpiece evenly and consistently without deep scratches, even on aluminum material. A perfect substitute for sandpaper and traditional polishing stones.

磨料 Grain	硬度 Hardness	用途 Application
WA	軟 / 無延展性 soft / inflexible	粗加工 roughing



	3 x 6 x 150	3 x 13 x 150	5 x 6 x 150	5 x 13 x 150
#60	PS-WA36150-60	PS-WA313150-60	PS-WA56150-60	PS-WA513150-60
#80	PS-WA36150-80	PS-WA313150-80	PS-WA56150-80	PS-WA513150-80
#120	PS-WA36150-120	PS-WA313150-120	PS-WA56150-120	PS-WA513150-120
#180	PS-WA36150-180	PS-WA313150-180	PS-WA56150-180	PS-WA513150-180
#220	PS-WA36150-220	PS-WA313150-220	PS-WA56150-220	PS-WA513150-220
#320	PS-WA36150-320	PS-WA313150-320	PS-WA56150-320	PS-WA513150-320
油石夾柄 Holders	XH-062	XH-133	—	XH-136

搭配氣動研磨機時，請將大和WA橡膠油石切成 35mm 以下的尺寸。

When using with air tools, cut Daiwa-Stick into several sections under 35mm each.

MIRACLE 魔術橡皮擦 MIRACLE-Eraser



適用於去除工件表面的輕微刮痕及損傷，方便使用且不必擔心斷裂，拋磨手感極佳。

Excellent for removing the light scratches easily and quickly.

粒度 Grit Size : #120

尺寸 Size (mm) : 10x20x60

訂購代號 / Order No. : ABR-ERASER-102060-WA120

FLASH 600 油石研磨液 FLASH 600 cutting fluid



提升傳統油石的切削性，減少磨耗並降低磨擦溫度，同時防止粉塵堵塞油石氣孔，使磨屑更順利地排除。

Enhance cutting force, reduce wear and frictional heat and prevent clogging.

容量 Capacity : 500 c.c. / 30 c.c.

訂購代號 / Order No. : FLASH600-500 (500 c.c.)
FLASH600-030 (30c.c.)

鑽石 銼刀

Diamond Files

Miracle 鑽石銼刀使用高品質鑽石粉，並以特殊的電鑄工法製作，優秀的切削力及耐用度讓您在加工時無往不利。

Diamond files are made with high-quality diamond powder. Ideal to work on all kinds of materials like carbide, metal, plastic, wood, glass, ceramics, etc.



Product details



TDF-130 平斜鑽石銼刀
Tapered Diamond Files

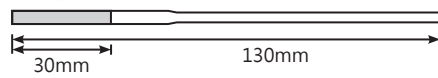

形狀 Shape	全長 L	鑽石長度 B	寬度 W	厚度 T	柄徑 Shank	粒度 Grit Size	訂購代號 Order No.
A	130	30	2	0.4~1.7	Ø3	#200	TDF-130A-200
						#400	TDF-130A-400
						#600	TDF-130A-600
B	130	30	4	0.4~1.7	Ø3	#200	TDF-130B-200
						#400	TDF-130B-400
						#600	TDF-130B-600
C	130	30	6	0.4~1.7	Ø3	#200	TDF-130C-200
						#400	TDF-130C-400
						#600	TDF-130C-600
D	140	50	3	—	Ø3	#400	TDF-130D-400

10支組套裝 (以上型號各1支) 10 pieces / set (one piece of each above) TDF-130S

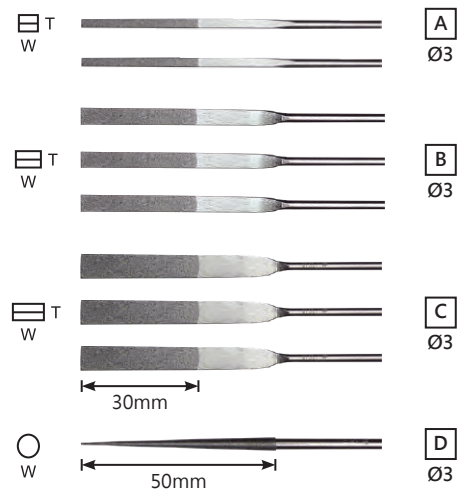

TDF-170 平斜鑽石銼刀
Tapered Diamond Files

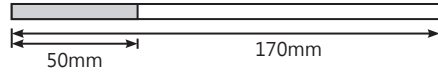

形狀 Shape	全長 L	鑽石長度 B	寬度 W	厚度 T	柄徑 Shank	粒度 Grit Size	訂購代號 Order No.
A	170	50	2.5	0.4~2.0	2.5x2.0	#120	TDF-170A-120 ★
						#200	TDF-170A-200 ★
						#400	TDF-170A-400 ★
						#600	TDF-170A-600 ★
B			4	0.5~2.0	4x2.0	#120	TDF-170B-120 ★
						#200	TDF-170B-200 ★
						#400	TDF-170B-400 ★
C			6	0.5~2.0	6x2.0	#120	TDF-170C-120 ★
						#200	TDF-170C-200 ★
						#400	TDF-170C-400 ★
D			8	0.5~2.5	8x2.5	#120	TDF-170D-120 ★
						#200	TDF-170D-200 ★
	#400	TDF-170D-400 ★					
						#600	TDF-170D-600 ★
12支組套裝 (★各一支) 12 pieces / set (with ★ mark)							TDF-170S

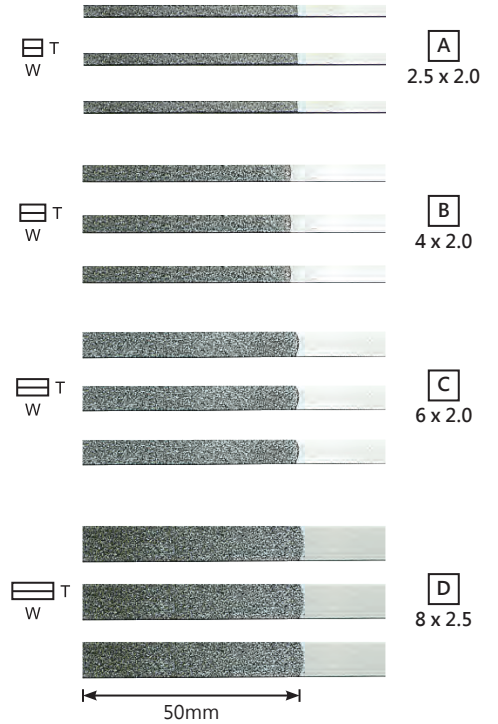

FDF-140 平型鑽石銼刀
Flat Diamond Files

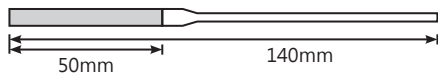

形狀 Shape	全長 L	鑽石長度 B	寬度 W	厚度 T	柄徑 Shank	粒度 Grit Size	訂購代號 Order No.
A	140	40	5.5	0.5	Ø3	#120	FDF-140A-粒度(Grit)
B		50		0.8		#200	FDF-140B-粒度(Grit)
C		50		1.0		#400	FDF-140C-粒度(Grit)
D		50		1.2			FDF-140D-粒度(Grit)
4支組套裝 / 4 pieces / set (以上型號同粒度各1支)							FDF-140S-粒度(Grit)

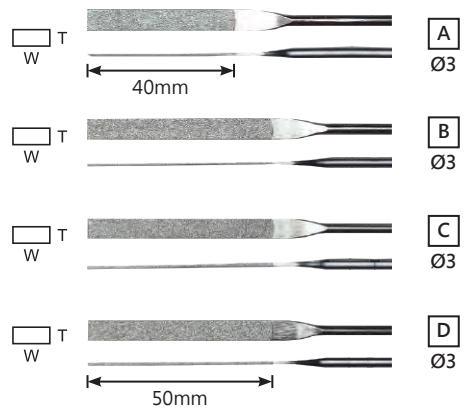

NDF-140 精密型鑽石銼刀

Needle Diamond Files



形狀 Shape	全長 L	鑽石長度 B	寬度 W	厚度 T	柄徑 Shank	粒度 Grit Size	訂購代號 Order No.
A	140	50	5.5	1.6	Ø3	#120	NDF-140A-粒度(Grit)
B			5	1.8			NDF-140B-粒度(Grit)
C			3	3			NDF-140C-粒度(Grit)
D			3.5	3.5			NDF-140D-粒度(Grit)
E			2.5	2.5			NDF-140E-粒度(Grit)
F			5.2	1.6			NDF-140F-粒度(Grit)
G			5.5	1.3			NDF-140G-粒度(Grit)
H			6	1.5			NDF-140H-粒度(Grit)
I			5	2			NDF-140I-粒度(Grit)
J			5	2.2			NDF-140J-粒度(Grit)

10支組套裝 / 10 pieces / set (以上型號同粒度各1支) NDF-140S-粒度(Grit)

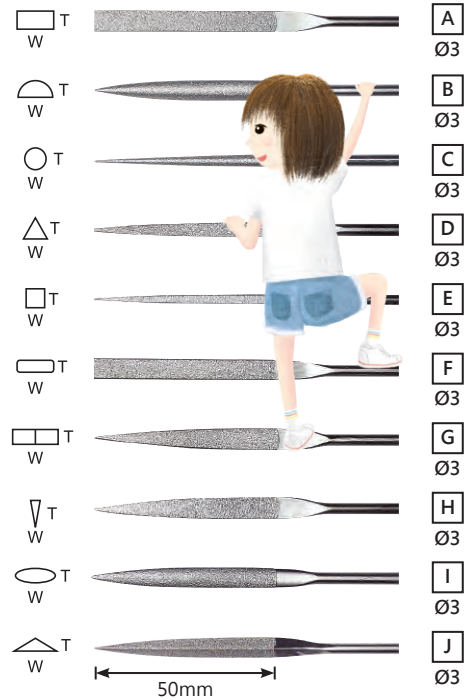

NDF-180 精密型鑽石銼刀

Needle Diamond Files



形狀 Shape	全長 L	鑽石長度 B	寬度 W	厚度 T	柄徑 Shank	粒度 Grit Size	訂購代號 Order No.	
A	180	70	7.2	1.5	Ø3.5	#120	NDF-180A-粒度(Grit)	
B			6	2.1			NDF-180B-粒度(Grit)	
C			3.5	3.5			#400	NDF-180C-粒度(Grit)
D			4	4				NDF-180D-粒度(Grit)
E			3	3				NDF-180E-粒度(Grit)

5支組套裝 / 5 pieces / set (以上型號同粒度各1支) NDF-180S-粒度(Grit)

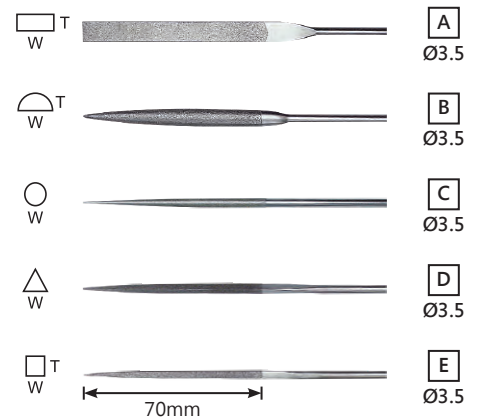

NDF-200 精密型鑽石銼刀

Needle Diamond Files

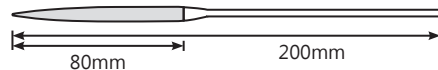

形狀 Shape	全長 L	鑽石長度 B	寬度 W	厚度 T	柄徑 Shank	粒度 Grit Size	訂購代號 Order No.	
A	200	80	7.8	1.8	Ø4	#120	NDF-200A-粒度(Grit)	
B			7	2.5			NDF-200B-粒度(Grit)	
C			4	4			#400	NDF-200C-粒度(Grit)
D			4.5	4.5				NDF-200D-粒度(Grit)
E			3.5	3.5				NDF-200E-粒度(Grit)

5支組套裝 / 5 pieces / set (以上型號同粒度各1支) NDF-200S-粒度(Grit)

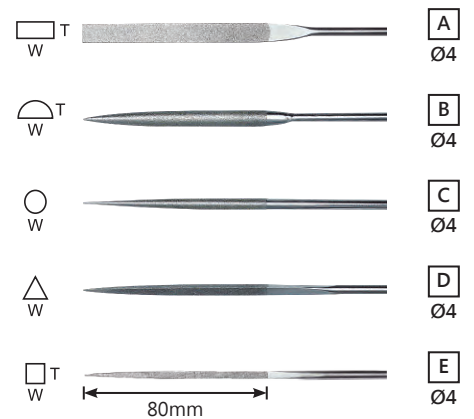

MTDF-80 機械用平斜鑽石銼刀

Machine Taper Diamond Files For Equipment

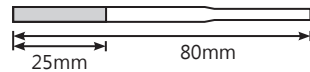

形狀 Shape	全長 L	鑽石長度 B	寬度 W	厚度 T	柄徑 Shank	粒度 Grit Size	訂購代號 Order No.
A	80	25	4	0.5~1.4	Ø3	#120	MTDF-80A-120
						#200	MTDF-80A-200
						#400	MTDF-80A-400
B	80	25	6	0.5~1.4	Ø3	#120	MTDF-80B-120
						#200	MTDF-80B-200
						#400	MTDF-80B-400
C	80	25	6	0.5~1.4	Ø3	#120	MTDF-80C-120
						#200	MTDF-80C-200
						#400	MTDF-80C-400
12支組套裝 / 12 pieces / set (以上型號各1支)							MTDF-80S

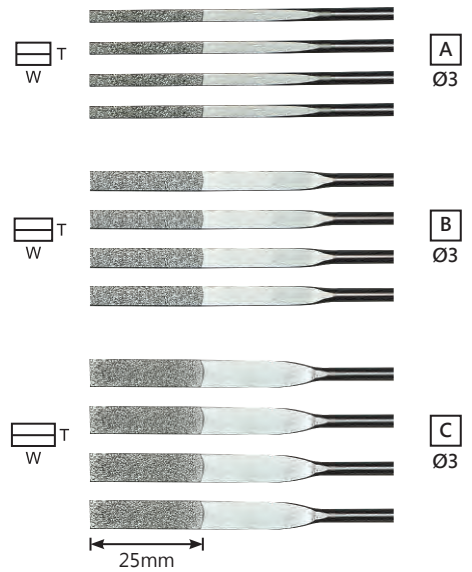

相關工具



XH-12夾柄 p.8

超音波研磨機 p.57

往覆式研磨機 p.60

MTDF-FA 鑽石彈性銼刀片

Machine Taper Diamond Flexible Files

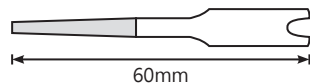

形狀 Shape	全長 L	鑽石長度 B	寬度 W	厚度 T	粒度 Grit Size	訂購代號 Order No.	
A	60	25	2~4	0.5~1.0	#150	MTDF-FAA-粒度(Grit)	
B			4			MTDF-FAB-粒度(Grit)	
C	70	40	6			#400	MTDF-FAC-粒度(Grit)
D			8			#600	MTDF-FAD-粒度(Grit)
E			10			MTDF-FAE-粒度(Grit)	

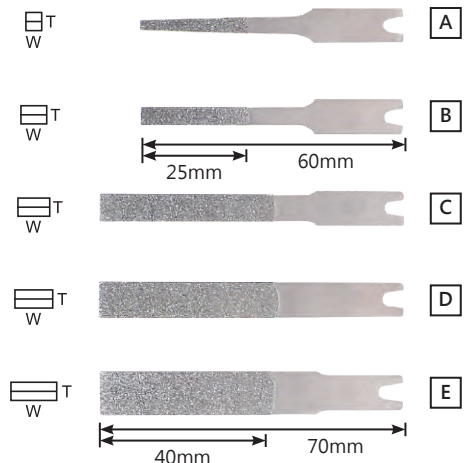

相關工具



XH-12夾柄 p.8

超音波研磨機 p.57

往覆式研磨機 p.60

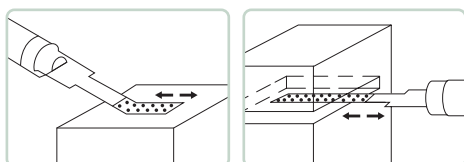

HDDF-215 鐵工用鑽石銼刀

Heavy Duty Diamond Files

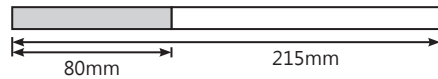

形狀	全長	鑽石長度	寬度	厚度	柄徑	粒度	訂購代號
Shape	L	B	W	T	Shank	Grit Size	Order No.
A	215	80	11	3.5	10.5x3	#100	HDDF-215A-100
B			10.5	4.4	10.5x3		HDDF-215B-100
C			5	5	5x5		HDDF-215C-100
D			7.7	7.7	10.5x3		HDDF-215D-100
E			5.1	5.1	5x5		HDDF-215E-100
5支組套裝 / 5 pieces / set (以上型號同粒度各1支)							HDDF-215S-100

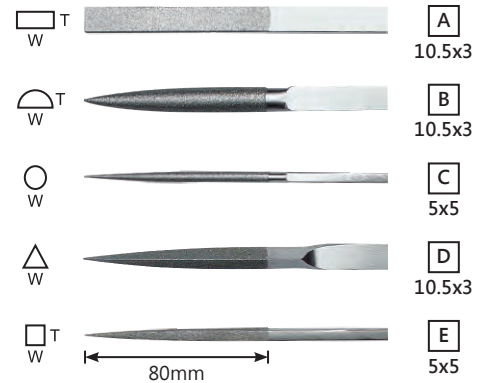

RDFA-140 異形鑽石銼刀

Radian Diamond Files

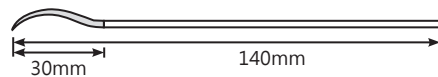

形狀	全長	鑽石長度	寬度	厚度	柄徑	粒度	訂購代號	
Shape	L	B	W	T	Shank	Grit Size	Order No.	
A	140	30	5.5	1.5	Ø3	#150	RDFA-140A-粒度(Grit)	
B			5	2			RDFA-140B-粒度(Grit)	
C			3.5	3.5			#200	RDFA-140C-粒度(Grit)
D			2.5	2.5			#400	RDFA-140D-粒度(Grit)
E			3	3			RDFA-140E-粒度(Grit)	
5支組套裝 / 5 pieces / set (以上型號同粒度各1支)							RDFA-140S-粒度(Grit)	

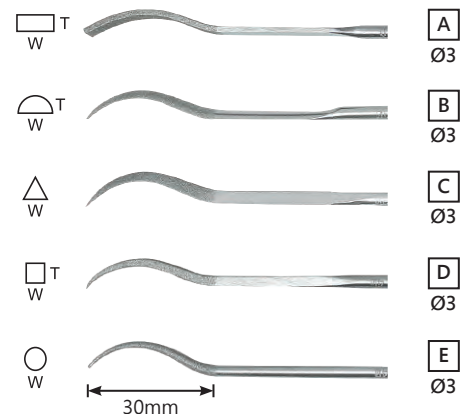

RDFB-150 異形雙頭鑽石銼刀

Radian Diamond Files

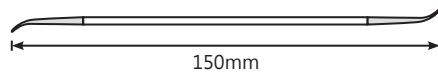

形狀	全長	鑽石長度	寬度	厚度	柄徑	粒度	訂購代號	
Shape	L	B	W	T	Shank	Grit Size	Order No.	
A	150	25	3	2	□3	#120	RDFB-150A-粒度(Grit)	
B		25	2	2			RDFB-150B-粒度(Grit)	
C		20	3	3			#200	RDFB-150C-粒度(Grit)
D		25	3	3			RDFB-150D-粒度(Grit)	
E		20	2.5	2.5			RDFB-150E-粒度(Grit)	
5支組套裝 / 5 pieces / set (以上型號同粒度各1支)							RDFB-150S-粒度(Grit)	

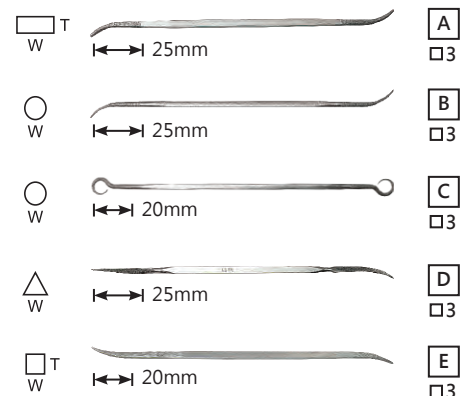

RDFC-150 異形鑽石銼刀

Radian Diamond Files

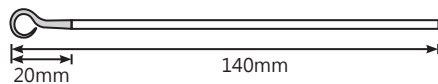

形狀 Shape	全長 L	鑽石長度 B	寬度 W	厚度 T	柄徑 Shank	粒度 Grit Size	訂購代號 Order No.
A	140	20	5	1.2	Ø3	#120	RDFC-150A-粒度(Grit)
B			2	2			RDFC-150B-粒度(Grit)
C			4	2			RDFC-150C-粒度(Grit)
D			3	3			RDFC-150D-粒度(Grit)
E			2.5	2.5			RDFC-150E-粒度(Grit)
F			3	1.2			RDFC-150F-粒度(Grit)
G			2	2			RDFC-150G-粒度(Grit)
H			6	1.2			RDFC-150H-粒度(Grit)
I			5	1.6			RDFC-150I-粒度(Grit)
J			3	1.2			RDFC-150J-粒度(Grit)

10支組套裝 / 10 pieces / set (以上型號同粒度各1支) RDFC-150S-粒度(Grit)

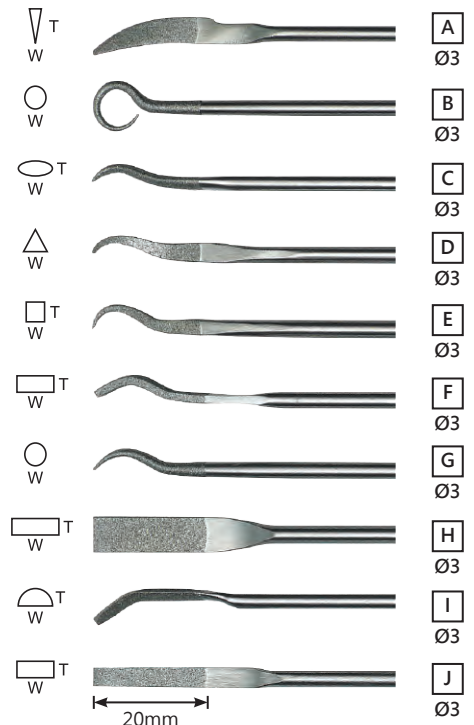

MRDF-65 機械用異形鑽石銼刀

Machine Radian Diamond Files For Equipment

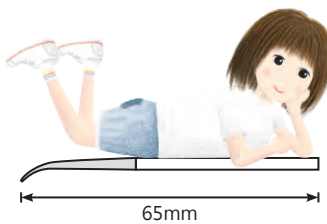

形狀 Shape	全長 L	鑽石長度 B	寬度 W	厚度 T	柄徑 Shank	粒度 Grit Size	訂購代號 Order No.		
A	65	20	5.8	1.2	Ø3	#150	MRDF-65A-粒度(Grit)		
B			3.2	1.4			MRDF-65B-粒度(Grit)		
C			5	2			MRDF-65C-粒度(Grit)		
D			3.2	1.4			MRDF-65D-粒度(Grit)		
E			3	3			MRDF-65E-粒度(Grit)		
F			30	2.5			2.5	#200	MRDF-65F-粒度(Grit)
G			3	3			MRDF-65G-粒度(Grit)		
H			20	3.2			1.5	MRDF-65H-粒度(Grit)	
I			3.2	1.5			MRDF-65I-粒度(Grit)		
J			4	2.5			MRDF-65J-粒度(Grit)		

10支組套裝 / 10 pieces / set (以上型號同粒度各1支) MRDF-65S-粒度(Grit)

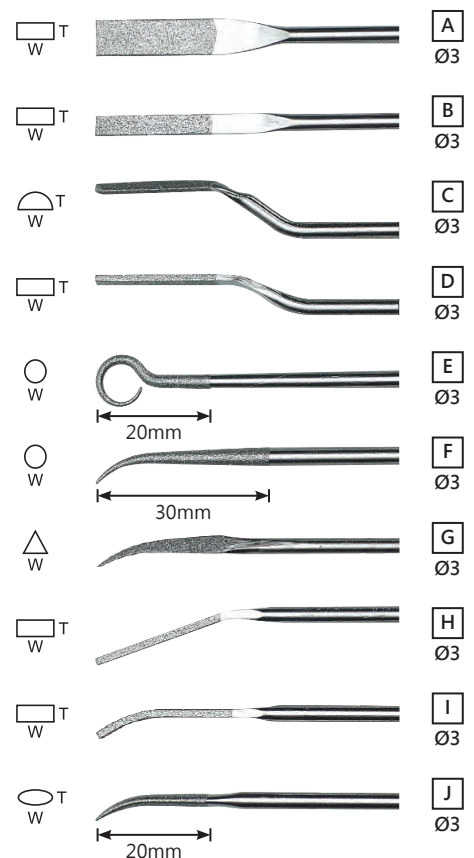

相關工具



鑽石 CBN 砂輪

Diamond & CBN Wheels

具備多種形狀及磨料，視您的加工需求作挑選。鑽石砂輪主要用於鋁、銅、鋅、陶瓷、玻璃等各種非鐵材料，CBN砂輪則適用於高速鋼、碳鋼、鍛造鋼、生鐵、鑄鐵及熱處理後的鋼材等。

Various types and abrasives for your processing work. Diamond wheels are suitable for non-metallic materials. CBN wheels are suitable for ferrous materials.



Product details

常用砂輪標準形狀
Common shapes

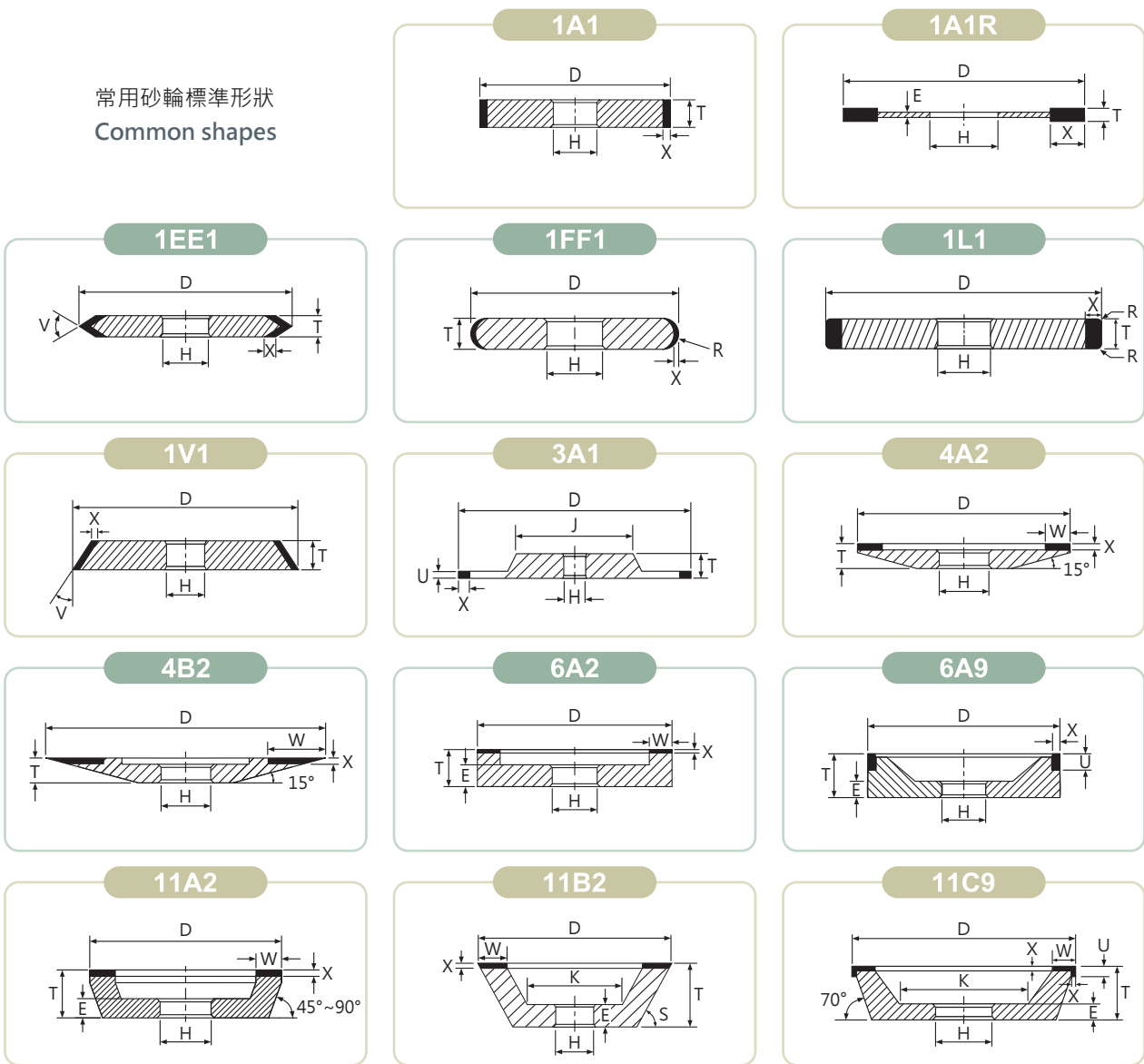

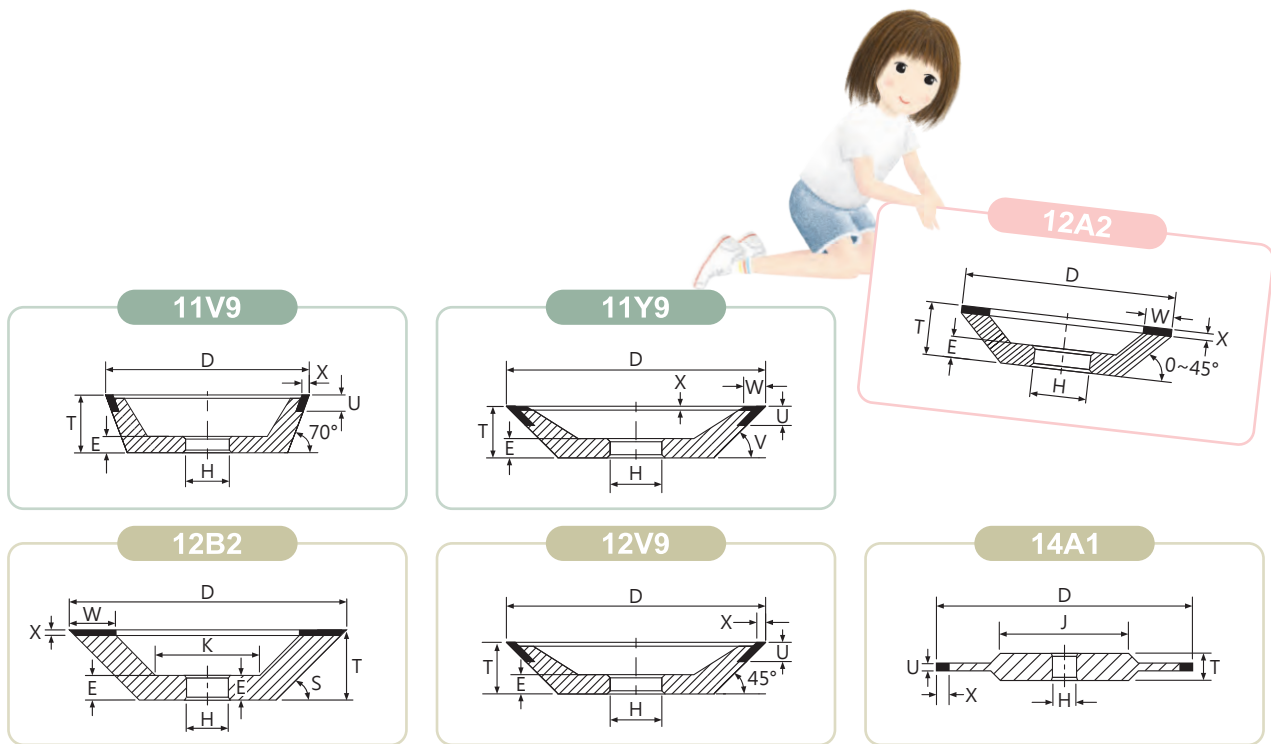

超級鑽石修整條 (樹脂砂輪專用)
 Super Diamond (For Resin Bond Wheels)

MIRACLE



3M



尺寸 Size=D x L	應用 Application	訂購代號 Order No.
1/4" x 1-3/4"	鑽石或 CBN 砂輪 · 厚度 1/4"(約6mm) Grinding wheel with up to 1/4" width.	GENF1909-MIRACLE GENF1909 (3M)
3/8" x 1-3/4"	鑽石或 CBN 砂輪 · 厚度 3/8"(約10mm) Grinding wheel with up to 3/8" width.	GENF1910-MIRACLE GENF1910 (3M)
1/2" x 2"	鑽石或 CBN 砂輪 · 厚度 5/8"(約15mm) Grinding wheel with up to 5/8" width.	GENF1911-MIRACLE GENF1911 (3M)
5/8" x 2"	大型砂輪 · 包含無心研磨砂輪 Large size wheel and centerless wheel. (use on OD of tool)	GENF1912-MIRACLE GENF1912 (3M)

Ex : 6 A 2 C

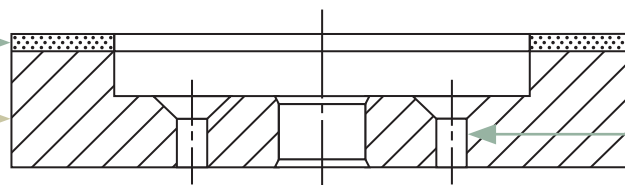

6 合金記號及基本形狀 Shapes of Steel Base

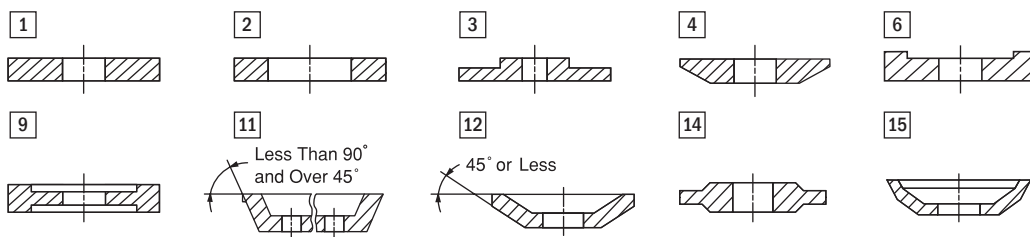

A 磨料層記號及斷面形狀 Shape of Abrasive Section

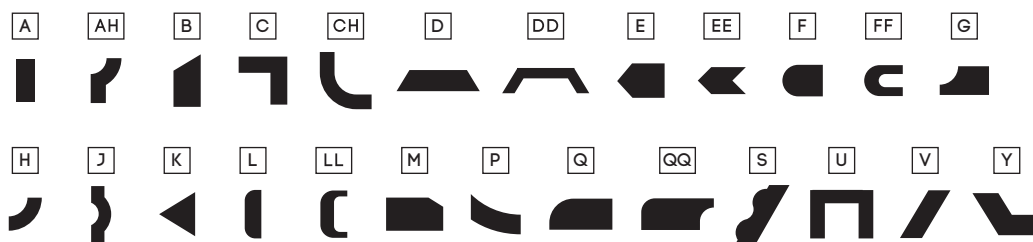

2 磨料層記號及位置 Location of Abrasive Section

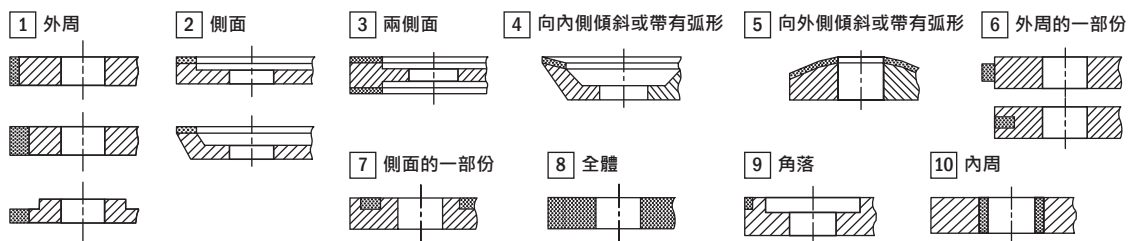

C 修改及記號 Other Parameter

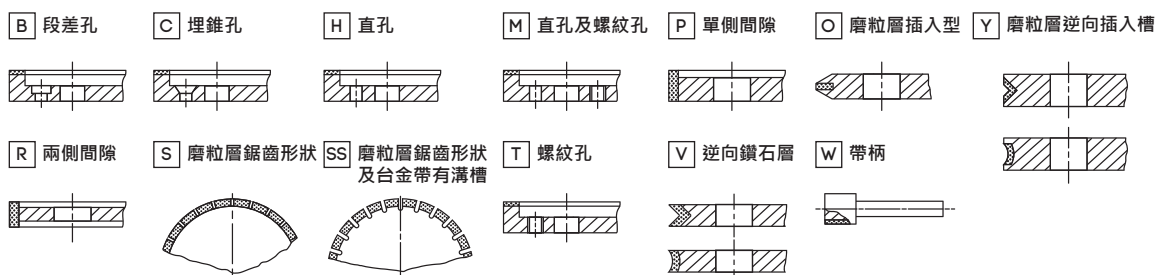

磨料種類

Selection of Abrasive Formula

EX.	磨料種類 Kind of Abrasive	結合度 Grade	集中度 Concentration	結合劑 Bond	磨料層厚度 Rim Thickness
	D 天然鑽石 Natural diamond SD 人造鑽石 Synthetic diamond SDC 人造金屬披覆鑽石 Synthetic metal coating diamond B (CBN) 氮化硼 Cubic boron nitride(CBN) BC 金屬披覆氮化硼 CBN with metal coating				
	SDC	N	75	R	3.0
	粒度 Grit Size				
	# 60 # 80 # 100 # 150 # 200 # 270 # 325 # 400...				

鑽石(DIA) 與氮化硼(CBN) 之使用時機

Recommended Applications



鑽石 DIA
Material recommended for cutting with PCD:
鋁及鋁合金 Aluminum and aluminum alloys
銅及青銅 Copper, brass and bronze alloys
鋅及鎂合金 Zinc and magnesium alloys
金及銀 Gold and Silver
鎢鋼 Tungsten carbide, presintered and sintered
碳 Carbon and graphite
陶瓷 Ceramics, unfired
環氧樹脂 (人造樹脂) Epoxy resins
橡塑膠 Plastics and rubber
玻璃纖維 Fiberglass composites
石墨 Graphite composites
合成樹脂 Phenolics
硬紙板及纖維板 Chipboard and fiberboard
氧化鐵 Oxide Ceramic materials
耐火材 Refractory Products

氮化硼 CBN (Cubic Boron Nitride)
Material recommended for cutting with CBN:
合金工具鋼 Alloy tool steel (45-68RC)
碳鋼 Carbon tool steel (45-68RC)
鋼模 Die steel (45-68RC)
高速鋼 High Speed steel (45-68RC)
生鐵 Chilled cast iron
鎳 Ni Hard
鍛造鋼 Forged steel
鑄鐵 Meehanite iron
鎳合金 Inconel 600
鎳鉻合金 Incoloy
鈷鉻鎢合金鋼 Stellite

鑽石修刀

Diamond Dressers

適用於傳統砂輪的修整、修銳、成型以及內外圓研磨...等。
Suitable for aluminum oxide grinding wheels on dressing, sharpening, forming and OD grinding.



Product details

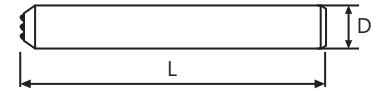

多石修刀

Multi Point Diamond Dressers



材質 (柄): SK4
Material (Shank): SK4
頂端: 天然鑽石
Tip: Natural diamond

鑽石顆數 Diamond Quantity	柄徑 Shank	鑽石分佈 Diamond Distribution	訂購代號 Order No.
3	Ø12 x 100L	▲▲▲	DDM-03101
3	Ø12 x 100L	▲	DDM-03102
5	Ø12 x 100L	▲▲	DDM-05101
6	Ø12 x 100L	▲▲	DDM-06101
7	Ø12 x 100L	▲▲	DDM-07101

適用於傳統砂輪 (PA, WA, GA ...等) 平面研磨。
Application: For surface dressing of aluminum oxide grinding wheels, like PA, WA, GA ...wheels.

單石修刀

Single Diamond Dressers



材質 (柄): SK4
Material (Shank): SK4
頂端: 天然鑽石
Tip: Natural diamond

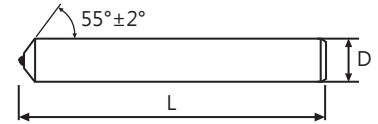

鑽石番號 Dia. Wt. Code	大約重量(克拉) Approx. Wt.(cts)	適用砂輪 Grinding Wheels Size(mm)	訂購代號 Order No.	柄徑 Shank
#5	0.18 cts	Ø150x25 or smaller	DDS-018	Ø10x80L or Ø12x100L
#10	0.20 cts		DDS-020	
#15	0.25 cts	Ø150~Ø300x25	DDS-025	
#20	0.35 cts		DDS-035	
#25	0.50 cts		DDS-050	
#33	0.75 cts		DDS-075	
#50	1.0 cts	Ø300~Ø450x25~40	DDS-100	
#75	1.5 cts	Ø450~Ø600x50~100	DDS-150	
#100	2.0 cts	Ø600 or bigger	DDS-200	

訂購範例 / Oder Ex.: DDS-020-10x80 or 12x100

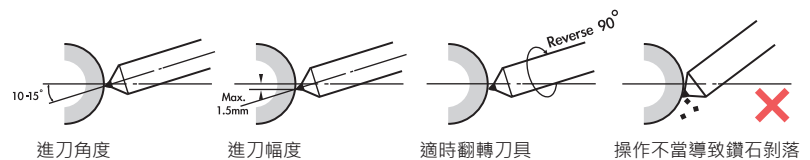

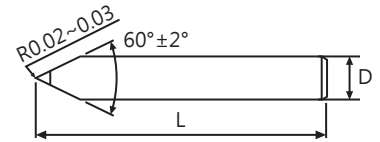

圓錐修刀
Coned Diamond Dressers



材質 (柄) : SK4
Material (Shank) : SK4
頂端 : 人造鑽石
Tip : Synthetic diamond

柄徑 Diameter	全長 Length	訂購代號 Order No.
3.175	25.4	DDC-001
3.175	50	DDC-002
6.35	50	DDC-003
9.5	50	DDC-004
10	50	DDC-005

適用於傳統砂輪 (PA,WA,GA...等) 精密研修 · 可搭配以下產品使用。
Application : For precision dressing of aluminum oxide grinding wheels, like PA, WA, GA...wheels. It is perfect to use together with following equipments.

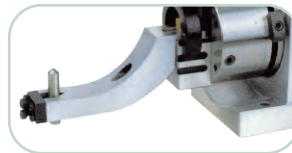

Ex : 沖子成型器、角度修整器、厚度修整器、角度成型器...等。
Punch former, angle dresser, duplex dresser and angle sine dresser...

角錐修刀
Pyramid Dressers



材質 (柄) : SK4
Material (Shank) : SK4
頂端 : 人造鑽石
Tip : Synthetic diamond

柄徑 Diameter	全長 Length	訂購代號 Order No.
Ø10	50	DDP-001
Ø12	50L / 100L	DDP-002
Ø6	23L	DDP-003
Ø8	24L	DDP-004

適用於內圓砂輪精修 · 以上為常用規格。
Application : For precision dressing of internal grinding wheels.

結合修刀

Impregnated Diamond Dressers

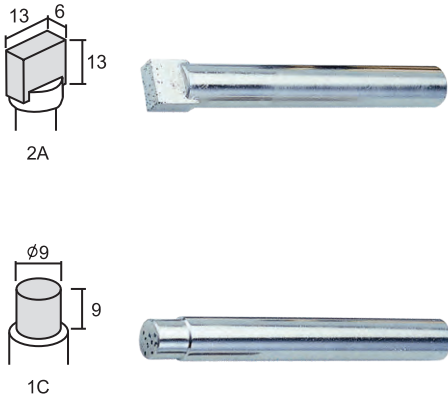

鐵柄形狀 Type	鐵柄尺寸 Shank	適用範圍 Applications	鑽石齒塊 Diamond Tips	粒度 Grit Size	訂購代號 Order No.
	Ø12 x 100 Ø12 x 50	無心研磨、圓筒研磨、 平面研磨。 砂輪尺寸： Ø300 x 25 ~ Ø500 x 63	2A	F	DDI-2AFC
				M	DDI-2AMC
				R	DDI-2ARC
	Ø12 x 50	For centerless, cylindrical, surface grinding. Wheel size : Ø300 x 25 ~ Ø500 x 63		F	DDI-2AFD
				M	DDI-2AMD
				R	DDI-2ARD
	Ø10 x 50 Ø12 x 50	一般用途之研磨 砂輪尺寸： Ø300 及以下 For general grinding. Wheel size : Ø300 or smaller	1C	F	DDI-1CFG
				M	DDI-1CMG
				R	DDI-1CRG

訂購範例 / Oder Ex. : DDI-2AFC-12 X 100 or 12 X 50

手持式結合修刀

Hand Diamond Dressers

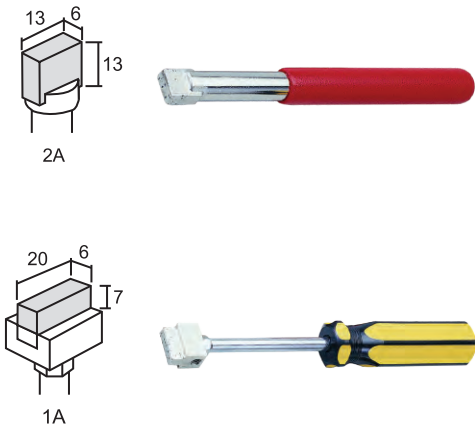

型式 Type	鑽石齒塊 Diamond Tips	粒度 Grit Size	訂購代號 Order No.
 總長 / Total length : 160mm	2A	R	DDH-01R
		F	DDH-01F
 總長 / Total length : 200mm 方向① Direction ① or 方向② Direction ②	1A	R	DDH-02R
		F	DDH-02F

鑽石粒度 Diamond Grit			適用被修整砂輪粒度 Grit size of grinding wheel to be dressed
R 粗目	Coarse	#16/20 + #20/30	#60 以下 (#60 or coarser)
M 中目	Medium	#30/50	#80 ~ #120
F 細目	Fine	#50/80	#150 以上 (#150 or finer)

鑽石切片

Diamond Electroplated Cutting Blades

柄徑有 $\varnothing 2.35\text{mm}$ / $\varnothing 3\text{mm}$ 可供選購，適用於切割金屬、玻璃、玉石、石材等各種材質。

Available in shank sizes $\varnothing 2.35$ and $\varnothing 3\text{mm}$. Suitable for cutting metal, glass, jade, stone and other materials.



Product details

A 型
Type A

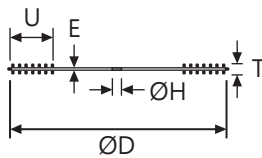
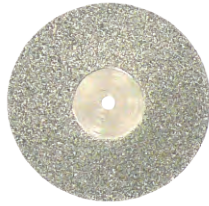

D 型
Type D

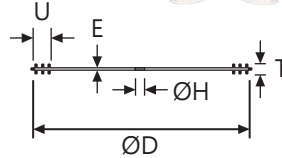

C 型
Type C

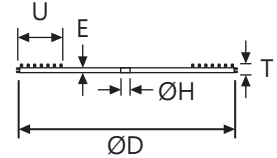

類型 Type	外徑 OD	U	E	T	H	粒度 Grit Size	訂購代號 Order No.
A 型 Type-A	22	6.5	0.15	0.3	1.7	#400	BM-2215AV
	22	6.5	0.2	0.4	1.7	#200	BM-2220AF
	22	6.5	0.2	0.5	1.7	#150	BM-2220AJ
	22	6.5	0.4	0.7	1.7	#150	BM-2240AJ
	25	8	0.2	0.4	1.7	#200	BM-2520AF
	25	8	0.2	0.5	1.7	#150	BM-2520AJ
	25	8	0.4	0.7	1.7	#150	BM-2540AJ
	25	8	0.4	0.8	1.7	#80	BM-2540AR
D 型 Type-D	22	2	0.15	0.3	1.7	#400	BM-2215DV
	22	2	0.2	0.4	1.7	#200	BM-2220DF
	22	2	0.2	0.5	1.7	#150	BM-2220DJ
	25	2	0.2	0.4	1.7	#200	BM-2520DF
	25	2	0.2	0.5	1.7	#150	BM-2520DJ
	25	2	0.4	0.8	1.7	#80	BM-2540DR
C 型 Type-C	22	6.5	0.2	0.4	1.7	#200	BM-2220CF

相關工具



鑽石磨棒

CBN

Diamond & CBN Burrs

Miracle 鑽石磨棒選用最高品質鑽石粉製造，出色的切削力及壽命讓您工作起來更加得心應手。

Miracle diamond burrs are made with high-quality diamond powder, offering excellent cutting performance and durability. Available in various shapes to suit your needs.



Product details

3mm柄套裝組系列-10支套裝組

3mm Shank Kit 10 Pieces / Set

10

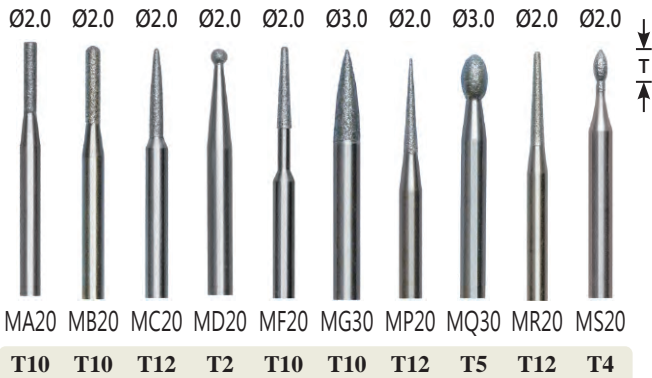

訂購代號 / Order No. : BDS-3-10 (DIA) 、BBS-3-10 (CBN)

3mm柄套裝組系列-20支套裝組

3mm Shank Kit 20 Pieces / Set

20

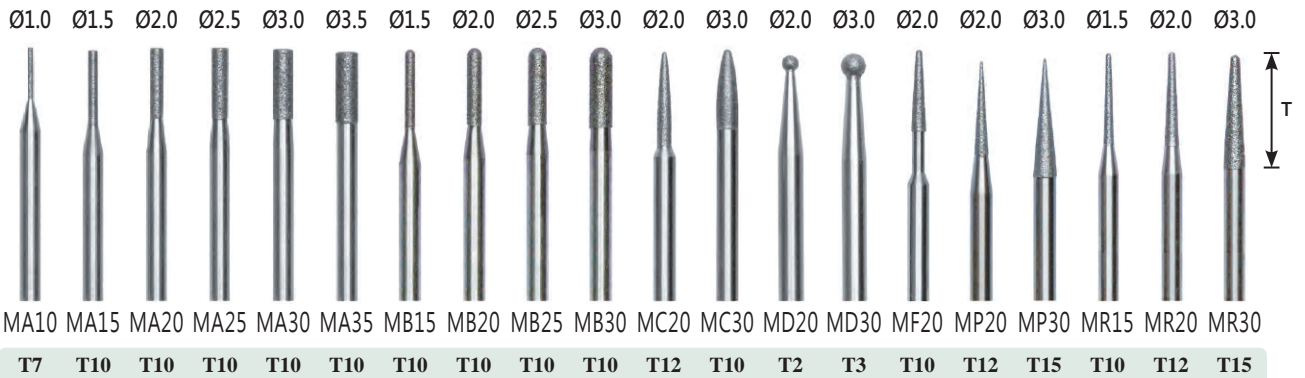

訂購代號 / Order No. : BDS-3-20 (DIA) 、BBS-3-20 (CBN)

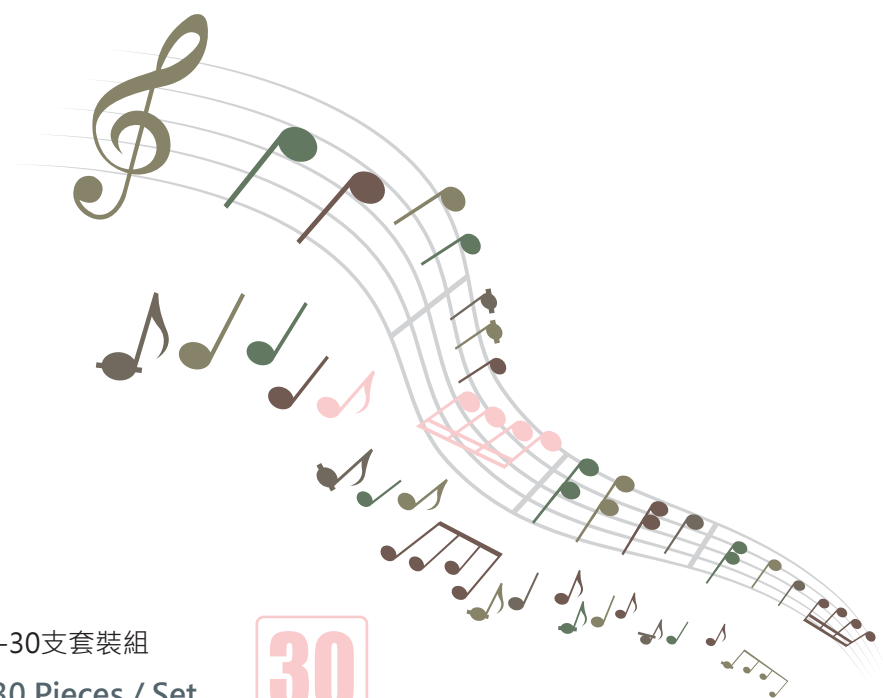

3mm柄套裝組系列-30支套裝組
3mm Shank Kit 30 Pieces / Set

30

Ø1.0 Ø1.5 Ø2.0 Ø2.5 Ø3.0 Ø3.5 Ø4.0 Ø5.0 Ø1.0 Ø1.5 Ø2.0 Ø2.5 Ø3.0 Ø3.5 Ø4.0 Ø5.0



MA10 MA15 MA20 MA25 MA30 MA35 MA40 MA50 MB10 MB15 MB20 MB25 MB30 MB35 MB40 MB50

T7 T10 T10 T10 T10 T10 T10 T10 T7 T10 T10 T10 T10 T10 T10 T10



Ø1.5 Ø2.0 Ø3.0 Ø4.0 Ø5.0 Ø2.0 Ø3.0 Ø3.0 Ø4.0 Ø2.0 Ø3.0 Ø1.5 Ø2.0 Ø3.0



MD15 MD20 MD30 MD40 MD50 MF20 MF30 MG30 MG40 MP20 MP30 MR15 MR20 MR30

T1.5 T2 T3 T4 T5 T10 T10 T10 T9 T12 T15 T10 T12 T15

訂購代號 / Order No. : BDS-3-30 (DIA) 、 BBS-3-30 (CBN)

圓柱形
Cylinder Shape

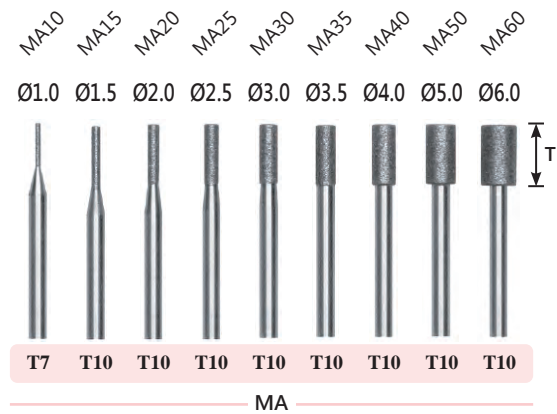

圓柱R形
Cylinder Shape / Round End

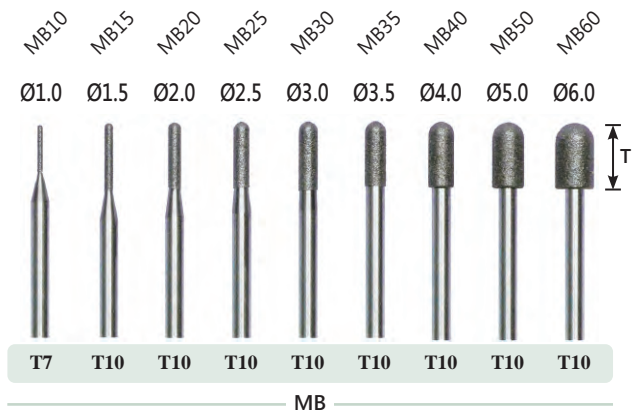

桃形
Taper Shape / Round End

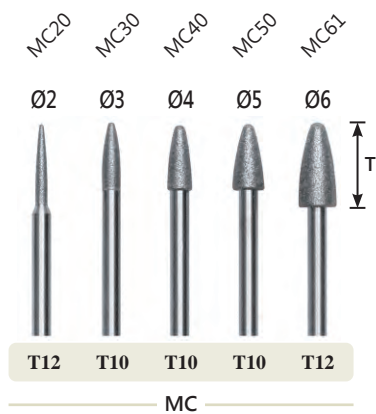

球形
Ball Shape

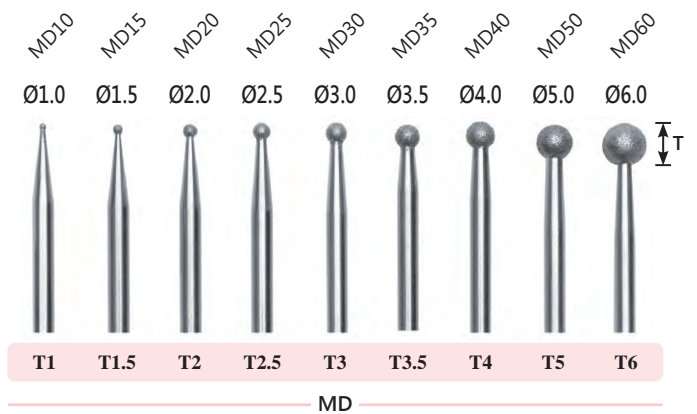

平斜形
Flat End Shape

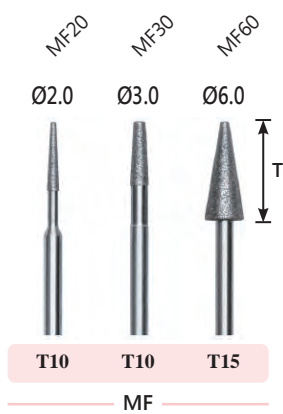

桃尖形
Taper Shape / Needle End

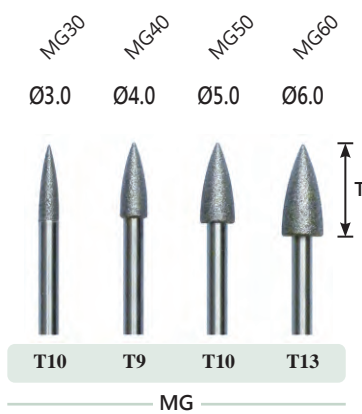

尖形
Needle End Shape

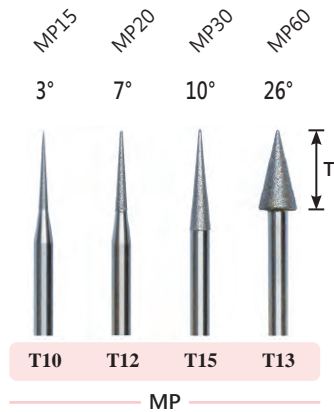

蛋形
Egg Shape

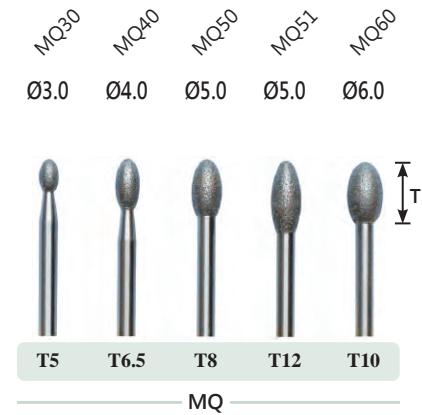

錐形
Awl Shape

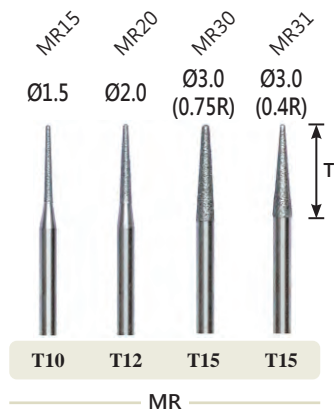

火鋸形
Match Shape

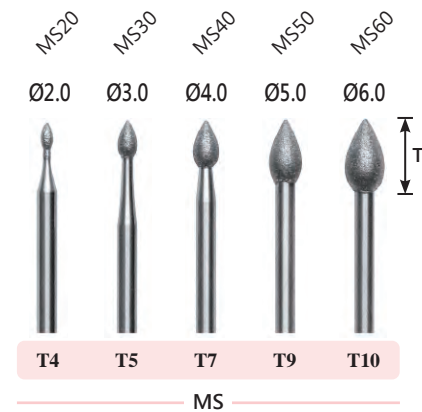

Laser engraving

Each diamond burr is engraved with the MIRACLE logo.

ØD 1.0~3.5 #150 / ØD 4.0 ~ above #120 / MP15 #400

鎢鋼 滾磨刀



Product details



Solid Carbides

高硬度鎢鋼製成，使用於雕刻、粗磨、成型。
適合鐵及非鐵金屬、玻璃纖維、壓克力、塑膠等
材質，亦適用於鎢鋼、陶瓷及硬化鋼材之切削。

Made of high hardness carbide. Ideal for
engraving, roughing, and forming on ferrous
metal, non-ferrous metal, glass fiber, acrylic,
plastic, and wood etc.

SA 圓筒形 Cylinder Shape

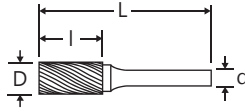

SB 圓筒形 / EC Cylinder Shape / EC

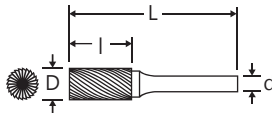

SC 圓筒 R 形 Cylinder Shape / Radius End

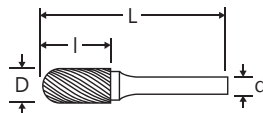

型號 MODEL	刃部直徑 Cutting Dia (D)	柄徑 Shank Dia (d)	刃部長度 Length of Cut (l)	總長 Overall Length (L)
SA-41M	1.5	3	6	38
SA-42M	2.5	3	11	38
SA-43M	3	3	14	38
SA-51M	6	3	12	51
SA-51M/EC	6	3	12	50
SA-52M	4	3	13	39
SA-53M	5	3	12.7	38
SA-13M	4	6	16	50
SA-14M	5	6	16	50
SA-1M	6	6	16	50
SA-2M	8	6	19	63
SA-3M	9.5	6	19	63
SA-5M	12.7	6	25	69
SA-6M	16	6	25	69
SA-7M	19	6	25	69
SA-9M	25	6	25	69

SB-43M	3	3	14	38
SB-51M	6	3	4.7	43
SB-13M	4	6	13	50
SB-14M	5	6	16	50
SB-1M	6	6	16	50
SB-2M	8	6	19	63
SB-3M	9.5	6	19	63
SB-5M	12.7	6	25	69
SB-6M	16	6	25	69

SC-41M	2.5	3	11	38
SC-42M	3	3	14	38
SC-51M	6.3	3	12.7	50
SC-52M	4	3	12.7	39
SC-53M	5	3	13	39
SC-13M	4	6	16	50
SC-14M	5	6	16	50
SC-1M	6	6	16	50
SC-2M	8	6	19	63
SC-3M	9.5	6	19	63
SC-5M	12.7	6	25	69
SC-6M	16	6	25	69
SC-7M	19	6	25	69
SC-9M	25	6	25	69

d: 交叉紋 (標準品) s: 單斜紋 (訂製品) nf: 鋁質及銅質用 (僅提供 6mm 柄)

d: double cut (standard) s: single cut (custom made) nf: nonferrous (only available for 6mm shank)

SD 球形
Ball Shape

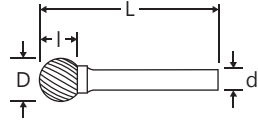

SE 蛋形
Oval Shape

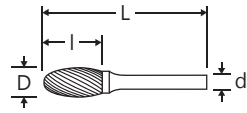

SF 桃形
Tree Shape

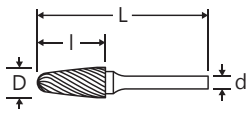

SG 桃尖形
Tree Shape Pointed End

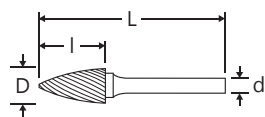

型號 MODEL	刃部直徑 Cutting Dia (D)	柄徑 Shank Dia (d)	刃部長度 Length of Cut (l)	總長 Overall Length (L)
-------------	-------------------------	---------------------	---------------------------	--------------------------

SD-41M	2.5	3	2.5	38
SD-42M	3	3	2.8	38
SD-51M	6.3	3	5	44
SD-52M	4	3	3.8	39
SD-53M	5	3	4.7	39
SD-14M	5	6	4	50
SD-1M	6	6	5	50
SD-2M	8	6	6.4	50
SD-3M	9.5	6	8	52
SD-5M	12.7	6	11	55
SD-6M	16	6	14	58
SD-7M	19	6	16	62
SD-9M	25	6	21	72

SE-41M	3	3	5.5	38
SE-51M	6.3	3	9.5	51
SE-53M	5	3	7.1	39
SE-1M	6	6	9.5	50
SE-3M	9.5	6	16	60
SE-5M	12.7	6	22	66
SE-6M	16	6	25	69
SE-7M	19	6	25	69

SF-41M	3	3	6	38
SF-42M	3	3	12	38
SF-51M	6.3	3	12.7	51
SF-53M	5	3	13	38
SF-14M	19	6	32	76
SF-15M	19	6	38	82
SF-1M	6	6	16	50
SF-3M	9.5	6	19	63
SF-5M	12.7	6	25	69
SF-6M	16	6	25	69
SF-7M	19	6	25	69

SG-41M	3	3	6	38
SG-43M	3	3	10	38
SG-44M	3	3	12	38
SG-51M	6.3	3	12	51
SG-53M	5	3	13	39
SG-1M	6	6	16	50
SG-2M	8	6	16	63
SG-3M	9.5	6	19	63
SG-5M	12.7	6	25	69
SG-6M	16	6	25	69
SG-7M	19	6	25	69
SG-15M	19	6	38	82

SH 火焰形
Flame Shape

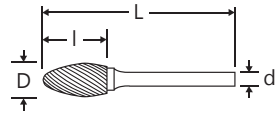

SL 錐 R 形
Taper Shape / Radius End

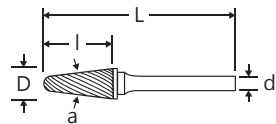

SM 圓錐形
Cone Shape

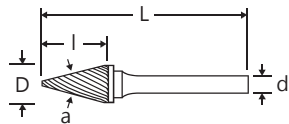

SN 皇冠形
Inverted Cone Shape

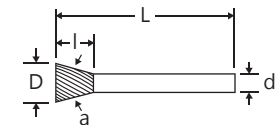

型號 MODEL	刃部直徑 Cutting Dia (D)	柄徑 Shank Dia (d)	刃部長度 Length of Cut (l)	總長 Overall Length (L)	角度 Angle (a)
-------------	-------------------------	---------------------	---------------------------	--------------------------	-----------------

SH-41M	3	3	6.3	38	-
SH-53M	5	3	9.5	39	-
SH-2M	8	6	19	63	-
SH-5M	12.7	6	32	76	-
SH-6M	16	6	36	80	-
SH-7M	19	6	41	85	-

SL-41M	3	3	6.5	38	8°
SL-42M	3	3	12.7	38	8°
SL-53M	5	3	12.7	38	14°
SL-1M	6	6	16	50	14°
SL-2M	8	6	22	69	14°
SL-3M	9.5	6	27	74	14°
SL-4M	12.7	6	28	76	14°
SL-5M	16	6	30	77	14°
SL-7M	19	6	38	85	14°

SM-41M	3	3	8.9	38	12°
SM-42M	3	3	11	38	14°
SM-43M	3	3	16	38	7°
SM-51M	6	3	12.7	51	22°
SM-53M	5	3	13	39	16°
SM-1M	6	6	12.7	50	22°
SM-2M	6	6	19	50	14°
SM-3M	6	6	25	50	10°
SM-4M	9.5	6	16	63	28°
SM-5M	12.7	6	22	69	28°
SM-6M	16	6	25	73	31°

SN-41M	2.5	3	3	38	10°
SN-42M	3	3	4	38	10°
SN-51M	6.3	3	6	51	10°
SN-53M	5	3	6.3	38	10°
SN-1M	6	6	8	50	10°
SN-2M	9.5	6	9	53	13°
SN-4M	12.7	6	12	57	28°
SN-6M	16	6	19	63	18°
SN-7M	19	6	16	60	30°

d: 交叉紋 (標準品) s: 單斜紋 (訂製品) nf: 鋁質及銅質用 (僅提供 6mm 柄)

d: double cut (standard) s: single cut (custom made) nf: nonferrous (only available for 6mm shank)

鑽石 油石



Product details

Diamond Polishing Stones

鑽石油石主要使用於各種刀具的刃部修磨，延長刀具壽命並提高加工物之表面光潔度。亦適用於鑄鋼、陶瓷及硬化鋼料的表面研磨。

Diamond Polishing Stone is considered as final finish for cutting tools. It is used to refine a surface by removing scratch lines and other surface imperfections. Therefore prolong the tools life and improve surface finish. Also suitable for surface grinding of tungsten, ceramics and hardened steels.

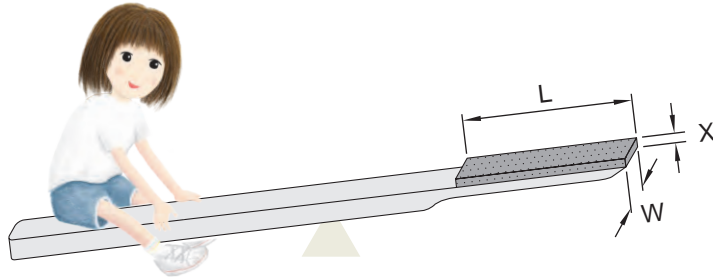

DPS-01

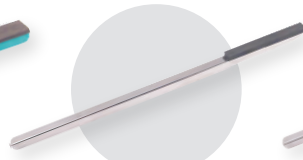

DPS-02

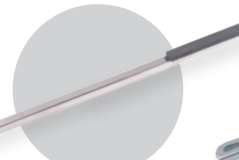

DPS-03

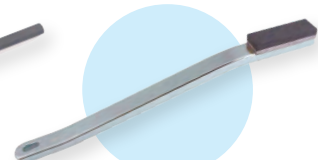

DPS-04

尺寸 W x (R) x X x L Size	柄部材質 Shank Material	訂購代號 Order No.
10x2x40	塑膠柄 Plastic	DPS-01- 粒度 (Grit)
5x2x40	鐵柄 Steel	DPS-02- 粒度 (Grit)
5x(2.5R)x4x40	鐵柄 Steel	DPS-03- 粒度 (Grit)
10x2x30	鋁柄 Aluminum	DPS-04- 粒度 (Grit)

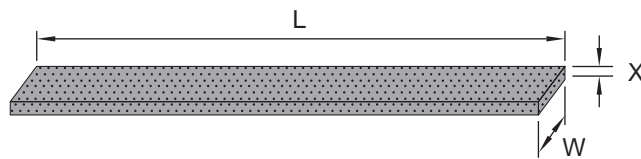

尺寸 W x X x L Size	柄部材質 Shank Material	訂購代號 Order No.
10x3x120	—	DPS-05- 粒度 (Grit)
6x3x100	—	DPS-06- 粒度 (Grit)
4x4x100	—	DPS-07- 粒度 (Grit)
13x3x100	—	DPS-08- 粒度 (Grit)
6x2x100	—	DPS-09- 粒度 (Grit)

粒度 / Grit Size :

#100, #200, #400, #600, #800, #1000, #1200, #1800, #2000, #3000, #5000

線刷系列

Brushes

適用於工件表面的拋光、刮痕處理及除鏽清潔。

Suitable for surface polishing, scratch removal and rust removal.



Product details

豬毛線刷

Bristle Brushes



馬毛線刷

Horse Bristle Brushes



羊毛線刷

Wool Brushes



銅線刷

Copper Wire Brushes

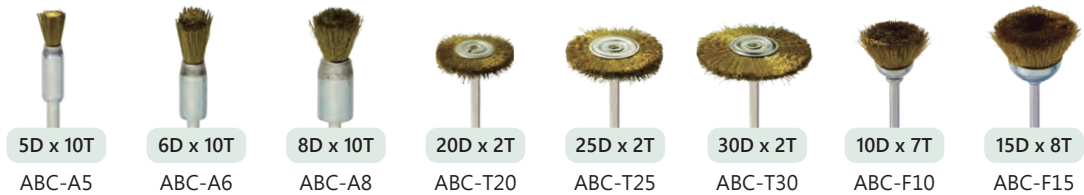

不銹鋼線刷

Stainless Steel Wire Brushes

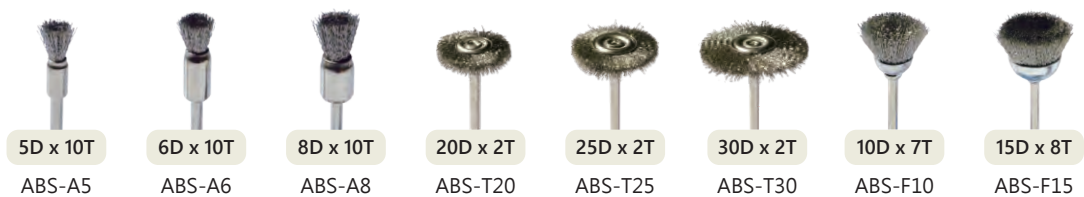

氧化鋁

帶柄砂輪

Aluminum Oxide Grinding Pins

鋒利且耐磨·鋼質的柄軸不易彎曲·適用於工具與模具業等·亦適用於鑄鋼、陶瓷及硬化鋼料之表面研磨。

Miracle Aluminum Oxide Grinding Pins made from PA abrasive. Long tool life makes your work efficiently.

粒度 / Grit Size : #120
柄徑 / Shank : 3mm



Product details

 ABP-256A	 ABP-308A	 ABP-410A	 ABP-510A	 ABP-612A	 ABP-816A	 ABP-1016A
 ABP-30B	 ABP-40B	 ABP-50B	 ABP-60B	 ABP-80B	 ABP-100B	 ABP-120B
 ABP-412J	 ABP-616J	 ABP-816J	 ABP-1016J	 ABP-612P	 ABP-815P	 ABP-1018P
 ABP-306K	 ABP-412K	 ABP-515K	 ABP-816K	 ABP-133E ABP-132E	 ABP-162E	 ABP-163E
 ABP-308T	 ABP-310T	 ABP-412T	 ABP-710T	 ABP-813R	 ABP-1224R	

鑽石砂布



Product details

Diamond Foil & Diamond Cloth

鑽石砂布以電鑄法將鑽石磨料佈滿銅箔表面，可自行裁切尺寸並黏貼在各式工具上使用，適合各種材料打磨。

Diamond foil is evenly sprayed with diamond powder on one side of the copper foil and with adhesive on the other side. It features a long-lasting durability, fast cutting and polishing on tungsten carbides, stones, glass and hard ceramic etc. and can be cut to the required size and shape and pasted on various tools for use.

粒度 Grit Size	50 x 100 mm	100 x 100 mm
#120	DPC-2012	DPC-3012
#150	DPC-2015	DPC-3015
#200	DPC-2020	DPC-3020
#300	DPC-2030	DPC-3030
#400	DPC-2040	DPC-3040
#600	DPC-2060	DPC-3060
#800	DPC-2080	DPC-3080
#1200	DPC-2120	DPC-3120
#1800	DPC-2180	DPC-3180



德國超微粒光學拋光布

Micro-Polierleinen (Made in Germany)

獲得專利的德國超微粒光學拋光布是精細研磨的最佳選擇。超微粒拋光布可應用在不同的材質，如金屬、木材、壓克力、塑料和玻璃等。美國 NASA 也將超微粒拋光布使用在拋光飛機的側窗。

MICRO-POLIERLEINEN designed for metallographic applications to fine grind a wide variety of laboratory materials. superior mineral grading, a unique resin top coat and a latex additive in the cloth. This combination resists water penetration, creating a durable, long-lasting polishing cloth. It's suitable for metal, wood, acrylic, plastic, glass and so forth.

粒度 Grit Size	14 x 15 cm (3 pcs / set)	15 cm x 15.2 meters
#1500	SP-FLO-1415-01500-S	SP-FLO-15015-01500
#1800	SP-FLO-1415-01800-S	SP-FLO-15015-01800
#2400	SP-FLO-1415-02400-S	SP-FLO-15015-02400
#3200	SP-FLO-1415-03200-S	SP-FLO-15015-03200
#4000	SP-FLO-1415-04000-S	SP-FLO-15015-04000
#6000	SP-FLO-1415-06000-S	SP-FLO-15015-06000
#8000	SP-FLO-1415-08000-S	SP-FLO-15015-08000
#12000	SP-FLO-1415-12000-S	SP-FLO-15015-12000

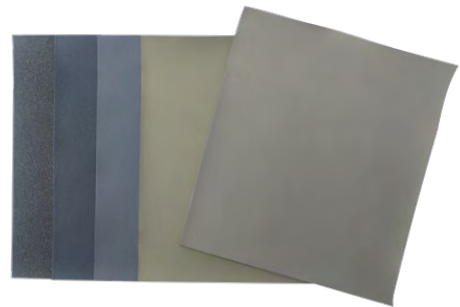

產品特點：顆粒細緻適合鏡面研磨，多用於光學產業。
Feature : It is with micro grain for mirror polishing, especially for optical industry.

海綿輪 牛皮輪



Product details

Sponge Elastic Grinding Pins Cow Leather Elastic Grinding Pins

高耐久且切削性佳 · 適用於一般精密模具研磨及一般表面拋光處理。

Excellent durability and cutting performance. Suitable for precision mold grinding and surface polishing.



海綿彈性帶柄砂輪
Sponge Elastic Grinding Pins

粒度 / Grit Size : #120

用途：鋁合金及鐵拋光
Application : Aluminum alloy
and iron polishing.



牛皮彈性帶柄砂輪
Cow Leather Elastic Grinding Pins

粒度 / Grit Size : #100

用途：一般金屬拋光
Application : Metal polishing.

外徑 x 厚度 x 柄徑 OD x Thickness x Shank	海綿輪訂購代號 Sponge Elastic Order No.	牛皮輪訂購代號 Cow Leather Order No.
3 x 12 x 3	ABR-03123	ABL-03123
4 x 13 x 3	ABR-04133	ABL-04133
5 x 16 x 3	ABR-05163	ABL-05163
6 x 17 x 3	ABR-06173	ABL-06173
8 x 20 x 3	ABR-08203	ABL-08203
10 x 20 x 3	ABR-10203	ABL-10203
13 x 20 x 3	ABR-13203	ABL-13203
22 x 4 x 3	ABR-22043	ABL-22043
13 x 20 x 6	ABR-13206	ABL-13206
15 x 25 x 6	ABR-15256	ABL-15256
20 x 25 x 6	ABR-20256	ABL-20256
25 x 25 x 6	ABR-25256	ABL-25256
38 x 10 x 6	ABR-38106	ABL-38106

Daiwa Rabin

日本大和海綿輪可均勻拋光物件表面，不會造成刮傷與碎屑堵塞，其鋒利的研磨特性可去除硬度較高的工件（如硬度近似 HRC60 之 SKD、HSS、FCD）上的毛邊或刮痕，也能輕易去除白鐵上的焊接痕跡。

Daiwa Rabin is able to polish workpiece surface evenly without causing any scratches or clogging. Not only can it remove burrs or scratches on high-hardness workpieces, around HRC60 such as SKD, HSS, and FCD, but it can also easily remove stainless steel weld beads.



Product details

Type CM



CM 為暢銷的產品，主要適用於壓鑄模和不銹鋼等多種模具，具備優異的切削力跟拋光彈性。

Type CM is a best-selling product, suitable for various molds, especially die-casting molds and stainless steel molds. With excellent cutting force and polishing performance.

研磨粒 (Abrasive Grain) : WA
粒度 (Grit Size) : #60, 80, 120, 180, 220, 320



Type OX

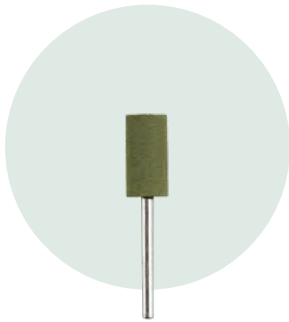

OX 系列磨料含多種晶粒，D款加入鑽石磨料後對於精加工拋光及難磨材料是理想的選擇。幾乎不損傷工件表面，也適合用在加工黃金、銅和其他有色金屬，研磨和拋光過程中呈現高質量及卓越的光潔度。

Type OX is mainly used for fine polishing. Easily remove rust from the surface of workpieces without damaging. It is proper for polishing gold, copper and other non-ferrous metals. In addition, it has been used for hairline processing of clock parts and SUS thin boards in home appliances.

研磨粒 (Abrasive Grain) : D
粒度 (Grit Size) : #60, 80, 120, 170, 230, 320, 400, 600, 800, 1000, 2000, 3000, 5000, 8000, 10000

Type UN



UN 擁有比 CM 更高的硬度，適用於倒角、去毛刺、去除硬質材料的鋒利毛邊。UN 並具備磨料頭部不易變形的特性，它能有效維持加工工件的形狀。對於去除細毛邊或維持加工精度部分效果尤佳。

Type UN has higher hardness than Type CM, suitable for chamfering and deburring. Due to the UN's characteristics, the abrasive is not easily deformed. During the deburring process, the rubber is hardened to prevent the burrs and edges from eating into rubber. Excellent in the deburring process on CNC lathe.

研磨粒 (Abrasive Grain) : WA
粒度 (Grit Size) : #80, 120, 180, 220, 320, 400, 600

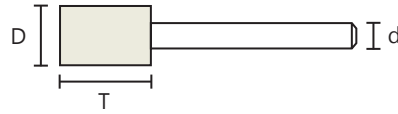

訂購範例： $\frac{\text{ABR-CM} - 04133 - \text{WA80}}{\text{型號} - \text{尺寸} - \text{磨料及粒度}}$

Order Ex.： $\frac{\text{ABR-CM} - 04133 - \text{WA80}}{\text{Model No.} - \text{Size} - \text{Abrasive \& Grit}}$

Type CM

適用研磨料 Abrasive Grain	粒度 Grit Size	結合劑 Bond	外徑 (D)	磨料長度 (T)	柄徑 (d)	訂購代號 Order No.
WA	#60	CMP66H	2	5	3	ABR-CM-02053-WA(粒度)(Grit)
		CMP66	3	8	3	ABR-CM-03083-WA(粒度)(Grit)
		CM55	4	13	3	ABR-CM-04133-WA(粒度)(Grit)
			5	15	3	ABR-CM-05153-WA(粒度)(Grit)
			6	17	3	ABR-CM-06173-WA(粒度)(Grit)
			8	20	3	ABR-CM-08203-WA(粒度)(Grit)
	#320	CM43	10	20	3	ABR-CM-10203-WA(粒度)(Grit)
			13	20	3	ABR-CM-13203-WA(粒度)(Grit)
			15	17	3	ABR-CM-15173-WA(粒度)(Grit)
			20	25	6	ABR-CM-20256-WA(粒度)(Grit)
			25	25	6	ABR-CM-25256-WA(粒度)(Grit)

Type OX

適用研磨料 Abrasive Grain	粒度 Grit Size	結合劑 Bond	外徑 (D)	磨料長度 (T)	柄徑 (d)	訂購代號 Order No.
D	#60	OX66TV (OX66STV for #3000+)	2	5	3	ABR-OX-02053-D(粒度)(Grit)
	#80 #800		3	13	3	ABR-OX-03133-D(粒度)(Grit)
	#120 #1000		4	13	3	ABR-OX-04133-D(粒度)(Grit)
	#170 #2000		5	15	3	ABR-OX-05153-D(粒度)(Grit)
	#230 #3000		6	17	3	ABR-OX-06173-D(粒度)(Grit)
	#320 #5000		8	20	3	ABR-OX-08203-D(粒度)(Grit)
	#400 #8000		10	20	3	ABR-OX-10203-D(粒度)(Grit)
	#600 #10000					

Type UN

適用研磨料 Abrasive Grain	粒度 Grit Size	結合劑 Bond	外徑 (D)	磨料長度 (T)	柄徑 (d)	訂購代號 Order No.
WA	#80	UN77TV	4	13	3	ABR-UN-04133-WA(粒度)(Grit)
			5	15	3	ABR-UN-05153-WA(粒度)(Grit)
			6	17	3	ABR-UN-06173-WA(粒度)(Grit)
			8	20	3	ABR-UN-08203-WA(粒度)(Grit)
			10	20	3	ABR-UN-10203-WA(粒度)(Grit)
			13	20	3	ABR-UN-13203-WA(粒度)(Grit)
			15	20	3	ABR-UN-15203-WA(粒度)(Grit)
			15	25	6	ABR-UN-15256-WA(粒度)(Grit)
			20	25	6	ABR-UN-20256-WA(粒度)(Grit)
			25	25	6	ABR-UN-25256-WA(粒度)(Grit)



鑽石微粉 鑽石膏



Product details

Diamond Compounds & Diamond Micron Powders

貓眼鑽石膏適用於各種模具、超硬合金、陶瓷、寶石...等之精密拋光及鏡面加工。

Cat Eyes diamond compounds are suitable for precision polishing, like all kinds of molds, ceramics, cemented carbide, jewels and mirror finishing.



貓眼鑽石膏

Cat Eyes Diamond Compounds

貓眼鑽石微粉

Cat Eyes Diamond Micron Powders

粒度 Grit Size	顆粒尺寸 Micron Range (μ)	用途 Function	訂購代號 Order No.
#14000	1 (0-2)	鏡面加工用 Mirror Polishing	KMP-14000-CE
#8000	3 (2-4)	精加工用 Fine Polishing	KMP-08000-CE
#5000	4.5 (3-6)		KMP-05000-CE
#3000	6 (4-8)		KMP-03000-CE
#2000	8 (5-10)		KMP-02000-CE
#1800	9 (6-12)		KMP-01800-CE
#1500	13 (10-16)	普通加工 Normal Polishing	KMP-01500-CE
#1200	15 (10-20)		KMP-01200-CE
#1000	17.5 (15-20)		KMP-01000-CE
#800	25 (20-30)		KMP-00800-CE
#600	35 (30-40)		KMP-00600-CE
#400	50 (40-60)	粗加工用 Rough Polishing	KMP-00400-CE
#200	90 (80-100)		KMP-00200-CE

粒度 Grit Size	100 克拉 100 carat
#14000	MDR-10140-CE
#8000	MDR-10080-CE
#5000	MDR-10050-CE
#3000	MDR-10030-CE
#1800	MDR-10018-CE
#1200	MDR-10012-CE
#800	MDR-10008-CE
#600	MDR-10006-CE
#400	MDR-10004-CE
#200	MDR-10002-CE

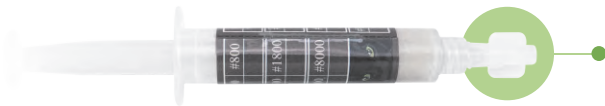

貓眼鑽石膏
Cat Eyes

貓眼及 Miracle 鑽石微粉品質精良、粒度準確，提供專業人員自行調配研磨材料。

Miracle diamond powders supply to professional engineer to create the special polishing process.

Miracle 鑽石膏依需求分為兩種等級，標準品針對寶石加工、中硬度模具...等。若使用在高硬度模具，建議您選擇較高鑽石等級的鑽石膏。

Miracle diamond compounds are available in two grades. "Standard" for polishing jewels and molds of medium hardness. "High Quality" for high hardness molds.



Miracle 鑽石膏

Miracle Diamond Compounds

粒度 Grit Size	顆粒尺寸 Micron Range (μ)	用途 Function	高品質代號 High Quality	標準品代號 Standard
#28000	0.5 (0-1)	鏡面加工用 Mirror Polishing	CMP-28000	KMP-28000
#14000	1 (0-2)		CMP-14000	KMP-14000
#8000	3 (2-4)	精加工用 Fine Polishing	CMP-08000	KMP-08000
#5000	4.5 (3-6)		CMP-05000	KMP-05000
#3000	6 (4-8)		CMP-03000	KMP-03000
#2000	8 (5-10)		CMP-02000	KMP-02000
#1800	9 (6-12)		CMP-01800	KMP-01800
#1500	13 (10-16)	普通加工 Normal Polishing	CMP-01500	KMP-01500
#1200	15 (10-20)		CMP-01200	KMP-01200
#1000	17.5 (15-20)		CMP-01000	KMP-01000
#800	25 (20-30)		CMP-00800	KMP-00800
#600	35 (30-40)		CMP-00600	KMP-00600
#400	50 (40-60)	粗加工用 Rough Polishing	CMP-00400	KMP-00400
#200	90 (80-100)		CMP-00200	KMP-00200

Miracle 鑽石微粉

Miracle Diamond Micron Powders

粒度 Grit Size	10 克拉 10 carat	50 克拉 50 carat
#28000	MDR-1280	MDR-5280
#14000	MDR-1140	MDR-5140
#8000	MDR-1080	MDR-5080
#5000	MDR-1050	MDR-5050
#3000	MDR-1030	MDR-5030
#1800	MDR-1018	MDR-5018
#1200	MDR-1012	MDR-5012
#800	MDR-1008	MDR-5008
#600	MDR-1006	MDR-5006
#400	MDR-1004	MDR-5004
#200	MDR-1002	MDR-5002

相關工具



標準品鑽石膏
Standard

高品質鑽石膏
High Quality

羊毛輪

Felt Grinding Pins

使用高級德國羊毛素材製成，羊毛密度高且不易變形，可保持工件亮度無痕。

Miracle felt grinding pins are made with premium German felt blocks. The high-intensive felt enables the felt bobs to maintain their shapes and keep workpiece smooth and shining.



Product details

3mm 柄徑 (3mm Shank)

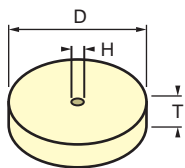
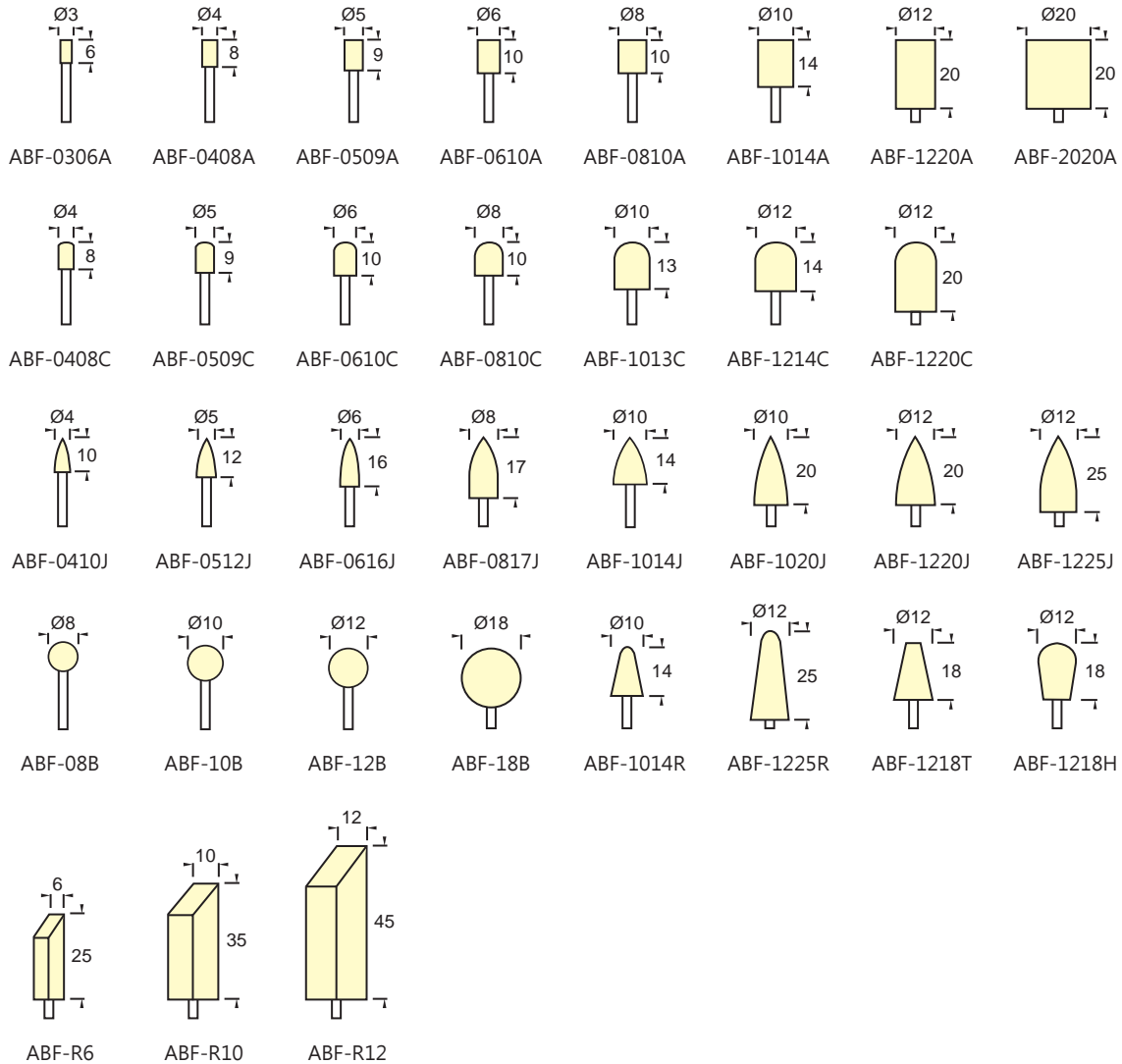

Size=D×T×H

尺寸 Size	訂購代號 Order No.
25×3×1.7	ABF-2503E
25×5×1.7	ABF-2505E

夾柄 Holder	
ABF-235S	ABF-300S

6mm 柄羊毛輪主要適用於如汽車模具...等之大型模具。我們提供中硬度的羊毛材質為標準品，另有 "軟質" 及 "硬質" 兩款可供您選擇。

Our standard 6mm shank felt grinding pins are available in medium hardness with the options for Soft and Hard densities. Suitable for large-sized molds, such as automobile molds.



6mm 柄徑 (6mm Shank)

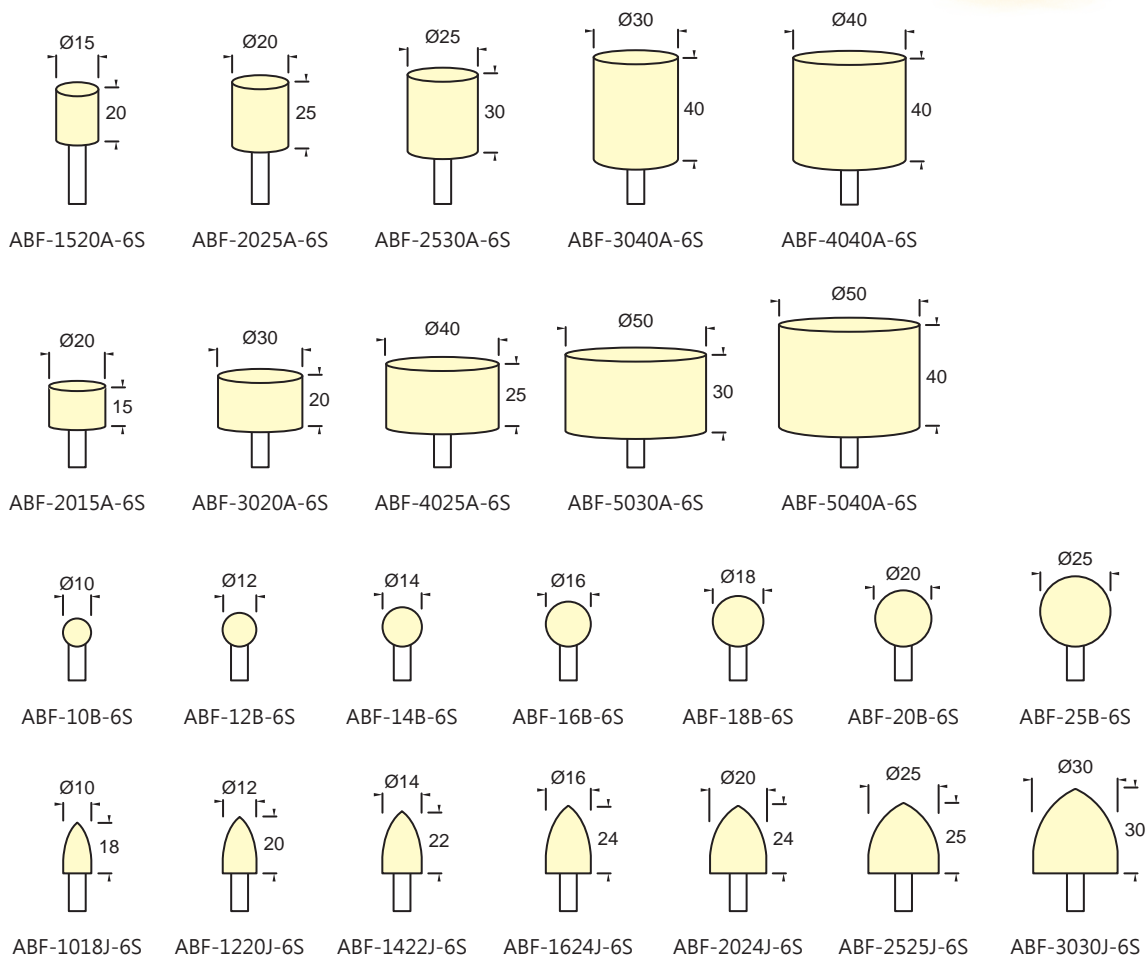

訂購範例: ABF-1520A-6S-M (中硬 - 標準品)
 ABF-1520A-6S-S (軟 - 訂製品)
 ABF-1520A-6S-H (硬 - 訂製品)

Order Ex: ABF-1520A-6S-M (Medium-Standard)
 ABF-1520A-6S-S (Hard-Option)
 ABF-1520A-6S-H (Soft-Option)

相關工具



電動 旋轉研磨機



Product details

Electric Rotary

與氣動研磨機相比，電動研磨機更安靜、操作手感更佳，可精準設定轉速或使用腳踏板進行控制，手機的使用壽命長、震動力道小，是協助您研磨加工的最佳選擇。

Electric grinder is quieter and less vibrating than air grinders. Users can set the speed precisely on control box or control speed with a foot pedal instead. Easy to use anytime and anywhere ; the best choice for your processing.



TR-500 50,000 轉無碳刷電動研磨機 50,000 rpm Brushless Electric Rotary

1. 無段式轉速液晶顯示操控裝置。
2. 50,000 轉超高轉速，並可自由設定順時針及逆時針旋轉。
3. 7.8 N.cm 超高扭力旋轉手機，在低轉速下仍有高扭力表現。
4. 本機可自我偵測錯誤顯示及工作記憶模式功能。
5. 隨機附贈腳踏開關，使您操控更容易。

- Non stage speed system with LCD display
- 50,000rpm high-powered brushless Handpiece with Right & Left turning ability.
- 7.8 N.cm strong torque at low speed.
- Self-diagnosis error display, work memory storage function.
- Hand / Foot speed control system.

TR-500 主機 (Control Box)

輸入電壓 : AC110V / AC230V
Power Input : AC110V / AC230V
保險絲 Fuse : 5A for 110V / 2A for 230V
重量 Weight : 2.5 kg
尺寸 Size : W 96 x L 207 x H 182

夾頭 Ø3為標準，另有 Ø2.34/Ø3.175可選擇
Collet Ø3 (standard)
Ø2.34/Ø3.175 (option)



TR-450 45,000 轉電動研磨機

45,000 rpm Electric Rotary

1. 無段式轉速操控裝置，可自由調整從 0 到 45,000rpm。
 2. 自動超載負荷偵測裝置及反饋系統，可延長機身壽命。
 3. 本機可自由設定順時針及逆時針旋轉。
 4. 超高扭力旋轉手機，提升工作效率。
 5. 隨機附贈腳踏開關，操控方式更加多元化。
- Non stage speed system, 0~45,000rpm can be adjusted freely.
 - Overload protection device.
 - Right & Left turning ability.
 - Strong torque handpiece.
 - Hand / Foot speed control system.



TR-450 主機 (Control Box)

輸入電壓 : AC110V ~ AC230V
Power Input : AC110V ~ AC230V
保險絲 Fuse : 3A
重量 Weight : 1.8 kg
尺寸 Size : W 130 x L 152 x H 103

夾頭 Ø3為標準，另有 Ø2.34/Ø3.175可選擇
Collet Ø3 (standard)
Ø2.34/Ø3.175 (option)



TR-400 40,000 轉電動研磨機

40,000 rpm Electric Rotary

1. 無段式轉速操控裝置，可自由調整從 0 到 40,000rpm。
 2. 本機可自由設定順時針及逆時針旋轉。
 3. 隨機附贈腳踏開關，操控方式更加多元化。
- Non stage speed system, 0~40,000rpm can be adjusted freely.
 - Right & left turning ability.
 - Hand / Foot speed control system.



TR-400 主機 (Control Box)

輸入電壓 : AC110V ~ AC230V
Power Input : AC110V ~ AC230V
保險絲 Fuse : 3A
重量 Weight : 1.3 kg
尺寸 Size : W 132 x L 140 x H 82

夾頭 Ø3為標準，另有 Ø2.34/Ø3.175可選擇
Collet Ø3 (standard)
Ø2.34/Ø3.175 (option)

超音波 研磨裝置



Product details

Ultrasonic Polishers

36W / 40W 以輕巧的外型搭配實惠的價格，單功能超音波研磨機更貼近使用者的需求，加工效率高並可大幅縮短研磨拋光時間。震動力道遠較氣動銼磨機小，可用於各種精密模具的細部加工或特殊形狀的研磨，尤其在寶石加工及電子類模具更加適合。

36W / 40W has a light and handy design with an attractive price, efficiently shortens the working time, and is much closer to the needs of users. It is perfect for all kinds of precision molds, like electronic molds, PCB boards, and jewel polishing and so on.



UL-36W+



UL-36W+ 直立式研磨機

Adjustable Tuning-Function Ultrasonic Polisher

輸入電壓 Power Input	: AC110V ~ AC230V
發振頻率 OSC Frequency	: 20KHZ~30KHZ (±3KHZ)
消耗功率 Power Output	: 40W max
尺寸 Size	: W 127 x L 151 x H 212
發振電源供應器重量 Power Supply Weight	: 1.8 kgs (±0.2kgs)
振動 Vibration	: 20,000~30,000 cycles / sec
振幅 Amplitude	: 3~35µm
輸出功率範圍 Output Power Range	: 5W~35W



UL-40W



UL-40W 單功能經濟型

Single Function Ultrasonic Polisher

輸入電壓 Power Input	: AC110V ~ AC230V
發振頻率 OSC Frequency	: 20KHZ~30KHZ (±3KHZ)
消耗功率 Power Output	: 40W max
尺寸 Size	: W 120 x L 190 x H 90
發振電源供應器重量 Power Supply Weight	: 1.8 kgs (±0.2kgs)
振動 Vibration	: 20,000~30,000 cycles / sec
振幅 Amplitude	: 3~35µm
輸出功率範圍 Output Power Range	: 5W~35W



手機 & 隨附配件 Accessories

Chucking System

請使用內附的扳手及手機固定座輕鬆的更換夾頭

By setting up the hand piece on the Stand Holder you can replace the collet easily with the supplied wrench.

氣動 研磨機



Product details

Air Grinders & Air Profiler-Linear

Miracle 氣動工具系列以高扭力與精準的同軸度，搭配多樣款式，讓您在各種加工環境皆能應付自如。

Miracle Air Tools are available in a complete range of handheld types with high-quality, durability and most competitive prices. Suitable for all applications from grinding to fine finishing.



APG-700 高速型氣動研磨機

High Speed Air Grinder

轉速 / Speed 70,000rpm
 重量 / Weight 110g
 夾頭 / Collet Ø3mm (Standard)
 Ø2.34mm (Standard)
 Ø3.175mm (Option)



MIG-0302 高扭力型氣動研磨機

High Torque Air Grinder

轉速 / Speed 60,000rpm
 重量 / Weight 100g
 夾頭 / Collet Ø3mm (Standard)
 Ø2.34mm (Standard)
 Ø3.175mm (Option)



MIG-0303 高扭力型氣動研磨機

High Torque Air Grinder

轉速 / Speed 60,000rpm
 重量 / Weight 135g
 夾頭 / Collet Ø3mm (Standard)



MIG-0303-PLUS 高扭力型氣動研磨機

High Torque Air Grinder

轉速 / Speed 65,000rpm
 重量 / Weight 75g
 夾頭 / Collet Ø3mm (Standard)
 Ø2.34mm (Standard)



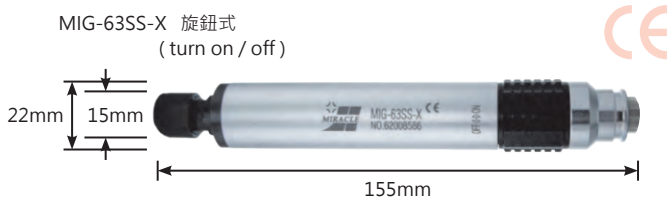
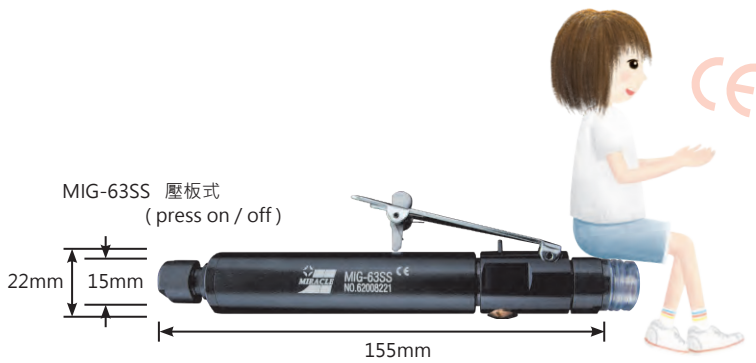

MIG-63SS/63SS-X 夾頭兩用型氣動研磨機 High Torque Dual-Collet Air Grinder

轉速 / Speed 35,000rpm
重量 / Weight 210g
夾頭 / Collet \varnothing 3mm (Standard)
 \varnothing 6mm (Standard)



MIL-03 0.3mm 往覆式氣動研磨機 0.3mm Stroke Air Profiler-Linear

轉速 / Speed 40,000rpm
重量 / Weight 190g
行程 / Stroke 0.3mm



MIL-07 0.7mm 往覆式氣動研磨機 0.7mm Stroke Air Profiler-Linear

轉速 / Speed 35,000rpm
重量 / Weight 190g
行程 / Stroke 0.7mm



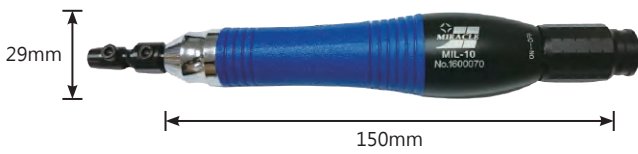

MIL-10 1.0mm 往覆式氣動研磨機
1.0mm Stroke Air Profiler-Linear

轉速 / Speed 28,000rpm
重量 / Weight 190g
行程 / Stroke 1.0mm



BE-007 0.7mm 往覆式氣動研磨機
0.7mm Stroke Air Profiler-Linear

轉速 / Speed 35,000rpm
重量 / Weight 210g
行程 / Stroke 0.7mm



MIA-120 120 度微型氣動研磨機
120° Angle Air Grinder

轉速 / Speed 22,000rpm
重量 / Weight 140g
夾頭 / Collet M7 螺桿



Standard:
ABP-CUP-060
(#60)-BOX

Option:
ABP-CUP-100
(#100)-BOX
ABP-CUP-150
(#150)-BOX

MIA-120-
PLATE-30

Standard:
ABN-O-060 (#60)
ABN-O-080 (#80)
ABN-O-100 (#100)
ABN-O-150 (#150)
ABN-O-240 (#240)
ABN-O-320 (#320)
ABN-O-400 (#400)
ABN-O-600 (#600)

大和 碗型研磨輪 環狀研磨片



Product details

Daiwa Rabin Integral Cup Wheel & Daiwa Rabin O Type Disk

適用於各式彎頭平面研磨機 (如: MIA-120) · 應用在細微的平面研磨以及沖壓或雷射切割等加工產生的毛刺。低轉速使用時 · 橡膠的彈性亦能減緩磨擦 · 防止工件反黑。O型研磨片另提供細粒度 · 大幅縮短加工程序。

Applicable for angle grinders (e.g. MIA-120). Excellent for lapping planes and deburring after punching and laser cutting. At low speed, the elasticity of the rubber reduces friction and prevents grinding burn. Finer grit is available for O Type Disk, it can cut down polishing process to save your time.

用途: 去除毛刺、焊接點及研磨拋光

適用材料: 鑄鐵、鋼鐵、不銹鋼及鋁、銅等非鐵金屬 · 亦適用於玻璃、陶瓷等多種材料

Application: De-burring, polishing and removing black scale and weld beads.

Materials: Cast iron, iron steel, stainless steel, aluminum, copper, general metals, ceramic and glass.

日本大和 海綿碗型研磨輪 (IT Cup)
Daiwa Rabin Integral Cup Wheel

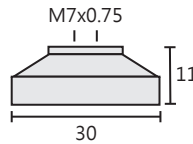

尺寸 / Size (mm): 30 x 11 x 6.3 (M7)

最高使用轉速 / Max RPM: 13,000rpm

粒度 / Grit Size: WA60, 80, 120, 180, 220, 320

訂購代號 / Order No.: ABR-ITCUP-粒度(Grit)

日本大和 海綿環狀研磨片
Daiwa Rabin O Type Disk

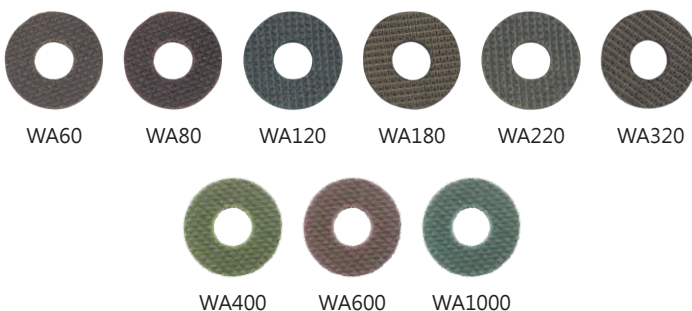
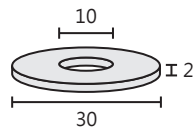

尺寸 / Size (mm): 30 x 2 x 10 (Adhesive type)

最高使用轉速 / Max RPM: 20,000rpm

粒度 / Grit Size: WA60, 80, 120, 180, 220, 320, 400, 600, 1000

訂購代號 / Order No.: ABR-O-DISK-粒度(Grit)-PACK

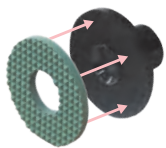

研磨片附背膠 · 可直接黏貼於膠墊上使用。

With adhesive backing, can be directly pasted on the rubber base for use.



由於橡膠的彈性 · 本產品會依據負荷而變形 · 且變形量極大 · 請遵循最高使用轉速的限制 · 以避免發生危險。

Feature of Daiwa Rabin's rubber elasticity is with reversible high deformability. Please operate at a speed lower than the maximum recommended RPM and avoid excessive force.



Ceramic Fiber Stones

CERATON is made from ceramic fibers bonded in thermosetting resin and exhibits superior strength, long life and no clogging compared to ordinary polishing stones. Suitable for all kinds of equipment like ultrasonic machines, air tools and also good by hand polishing.



Miracle Polishing Stones

Miracle Polishing Stones are made in Japan or U.S. for tooling. The excellent grains are for maintaining the stability, less abrasion, shortening machining time, removing layer after EDM processing, and showing outstanding cutting performance.

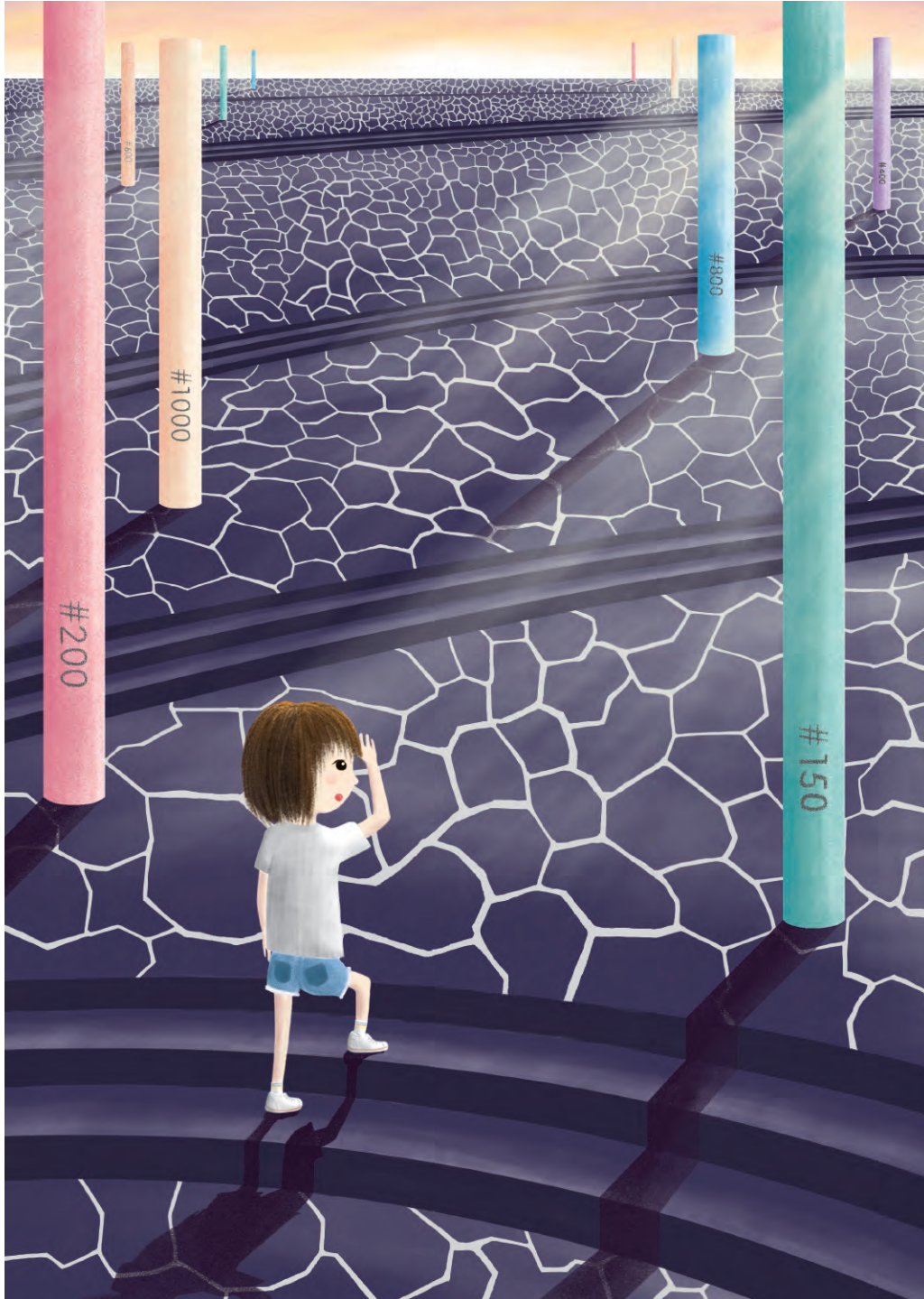

Crystal Fiber Stones

Cristone stands for Crystal Stone made from using the highest quality, chemically produced crystal fibers. The crystal line structure of the crystal fibers offers high polishing efficiency and incredible bending strength. Extremely strong for tight ribs and slots, excellent for EDM removal.



Sponge Elastic Grinding Pins & Cow Leather Elastic Grinding Pins

Excellent durability and cutting performance. Suitable for precision mold grinding and surface polishing.



Cristone[®] Matrix

The Mini Crystal nano Fiber Stones





Diamond Files

Diamond files are made with high-quality diamond powder. Ideal to work on all kinds of materials like carbide, metal, plastic, wood, glass, ceramics, etc.



Miracle Tools

We provide all kinds of polishing tools. Just come to us and open the door to choose what you need heartily.

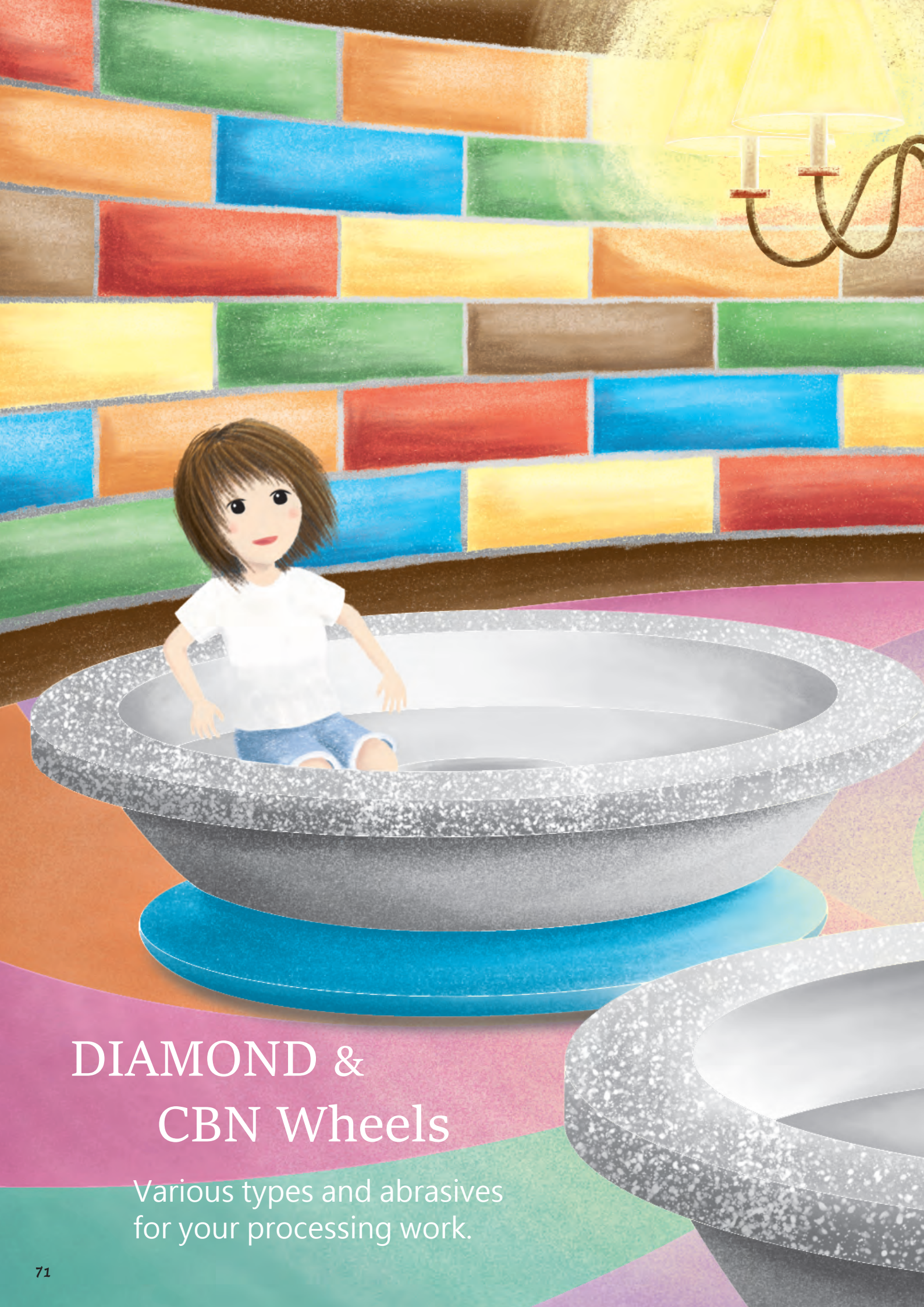

DIAMOND & CBN Wheels

Various types and abrasives
for your processing work.





Diamond & CBN Burrs

Miracle diamond burrs are made with high-quality diamond powder, offering excellent cutting performance and durability. Available in various shapes to suit your needs.



Air Grinders & Air Profiler-Linear

Miracle Air Tools are available in a complete range of handheld types with high-quality, durability and most competitive prices. Suitable for all applications from grinding to fine finishing.



Electric Rotary

Electric grinder is quieter and less vibrating than air grinders. Users can set the speed precisely on control box or control speed with a foot pedal instead. Easy to use anytime and anywhere ; the best choice for your processing.



Ultrasonic Polishers

36W / 40W has a light and handy design with an attractive price, efficiently shortens the working time, and is much closer to the needs of users. It is perfect for all kinds of precision molds, like electronic molds, PCB boards, and jewel polishing and so on.



What a Wonderful Miracle World

In the future, we will continue to push the boundaries of technological innovation and product upgrades to meet our customers' ever-evolving demands for our products.

Welcome to Yataghan -

YATAGHAN ENTERPRISE CO., LTD. is a dedicated manufacturer of ceramic fiber stones and precision diamond tools. Since our inception, we have garnered widespread acclaim for our excellent high-quality products, innovative design concepts, and customer-centric service.

Our mission is to enhance our customers' work efficiency through exceptional products and become an industry leader.



We offer a wide range of polishing tools catering to the diverse needs of our customers. Also, we insist on using premium materials for ensuring the durability and stability of our products. Believing in quality is the essence of our products and we implement a rigorous quality control process, ensuring that each product undergoes thorough inspections before reaching our customers' hands.

Thank you for choosing Miracle Tools. We look forward to working hand in hand with you to create a glorious future.

Miracle

雅提企業有限公司

www.yataghan.com.tw